

Dictionary-IV[®]

User Guide



Version 8.9.0

7 Cedar Grove Lane, Suite 30 • Somerset, NJ 08873
Telephone: 732-560-1377 • 800-524-0430
Fax: 732-560-1594

Internet address: <http://www.tbred.com>

Published by:
Thoroughbred Software International, Inc.
7 Cedar Grove Lane, Suite 30
Somerset, New Jersey 08873

Copyright © 2024 by Thoroughbred Software International, Inc.

All rights reserved. No part of the contents of this document may be reproduced or transmitted in any form or by any means without the written permission of the publisher.

Document Number: DU8.9.0M101

The Thoroughbred logo, Swash logo, and Solution-IV Accounting logo, OPENWORKSHOP, THOROUGHbred, VIP FOR DICTIONARY-IV, VIP, VIPImage, DICTIONARY-IV, and SOLUTION-IV are registered trademarks of Thoroughbred Software International, Inc.

Thoroughbred Basic, TS Environment, T-WEB, Script-IV, Report-IV, Query-IV, Source-IV, TS Network DataServer, TS ODBC DataServer, TS ODBC R/W DataServer, TS DataServer for Oracle, TS XML DataServer, TS DataServer for MySQL, TS DataServer for MS SQL Server, GWW Gateway for Windows, Report-IV to PDF, TS ReportServer, TS WebServer, TbredComm, WorkStation Manager, FormsCreator, T-RemoteControl, Solution-IV Accounting, Solution-IV Reprographics, Solution-IV ezRepro, Solution-IV RTS, and DataSafeGuard are trademarks of Thoroughbred Software International, Inc.

Other names, products and services mentioned are the trademarks or registered trademarks of their respective vendors or organizations.

INTRODUCTION

Operating System Support

UNIX, Linux, and Windows

For specific information, please contact your Thoroughbred Sales Representative.

Manual Organization

The Dictionary-IV Reference Library consists of four volumes. Refer to the preface for an overview of each volume, or refer to the section titled How This Manual is Organized.

Dictionary-IV

Thoroughbred Dictionary-IV is a family of products that together provide a complete 4GL (fourth generation language) environment for the development of business application software.

Overview

Dictionary-IV separates application logic from application data. The process executes 4GL Script-IV code and 3GL code (using Dictionary-IV APIs) and makes reference to Dictionary-IV for all data items, data file definitions, screen designs, and user messages. These definitions are external to the application logic.

Components

Dictionary-IV

Is the system dictionary. It is a DBMS (Database Management System), which provides the foundation for the Thoroughbred Dictionary-IV family of products. It also contains the public programs known as the Dictionary-IV APIs.

Script-IV

Provides the 4GL procedural language constructs required for developers to build applications quickly. It uses structured, English-like commands that allow you to create applications using less code.

Report-IV

Is a comprehensive report generator. It runs with Dictionary-IV, which defines the type and location of data items. Report-IV combines data from multiple files, file structures, file systems, and operating systems. It can access applications across multiple machines.

Query-IV

Allows the software developer to place a query management system in the hands of the end-user. It is based on the industry standard SQL (Structured Query Language). Queries can be stored and retrieved later and can be transferred to a Report-IV format. Query-IV runs with Dictionary-IV, which defines the type and location of data items. The output may also be directed to Thoroughbred Gateway for Windows for further processing by any workstation-based application under Microsoft Windows.

Source-IV

Is a source code management system. Its editor has many advantages over the native Script-IV editor, including:

- An elegant interface with advanced editing functions
- Source-code management capabilities
- Edit histories that enable you to track and undo changes

OPENworkshop

OPENworkshop is an object-oriented development environment. Object-oriented programming focuses on data objects and the operations that you perform on them.

With OPENworkshop, Dictionary-IV applications are immediately applicable to object-oriented technology. The benefits of this technology are:

- Increased productivity in development
- Increased productivity in maintenance

There is no main program. The information content and structure can be implemented as Dictionary-IV Formats. The operations are implemented as Methods, which are procedural code written in Script-IV or Basic and associated with the data object.

The CONNECT functions provide the interconnections between the data and the functional options available to the user.

CONNECT Directive that allows for “connections” to be made from one object to another. A CONNECT may be made directly. For example: a Menu can CONNECT VIEW to display a defined view. It can also be made through a METHOD, which contains procedural code that modifies the behavior of the CONNECT.

A CONNECT can be invoked at pre- and post-processing stages of data entry, or when defined Function Keys are used.

METHOD Basic or Script-IV code that can be associated with OPENworkshop objects. Typically, Methods will be associated with pre- or post-processing of data in Screens or Views, or may be invoked as I/O Triggers associated with a Link.

Dictionary-IV Overview

Dictionary-IV is a DBMS. It serves as a repository of information and is used by application designers to store the description and definition of data elements, file formats, screens, menus, views, messages, and help.

Thoroughbred Dictionary-IV is a primary component of Thoroughbred Dictionary-IV. It is a dictionary-driven system that provides a database manager, menu manager, screen developer, message dictionary, and help manager.

In Thoroughbred Dictionary-IV, portions of the program are externalized, or separated, from the program, and are defined in a system dictionary.

The following are the components of Dictionary-IV:

Formats

Define the data item names, attributes (such as validation rules), and keys within a logical or physical file.

Global Cross Reference

Contains definitions of all system-wide data elements. For each element, the Global Dictionary records name, type, validation rules, default value, and access rules (for security).

Whenever you access an item defined in the Global Dictionary from a format, it will be treated consistently and reliably.

Screens

Control the layout, coloring, and other display attributes of user interface screen displays. Fields can be straight data-entry, lookup, calculated, or scrolled.

Views

Display multiple records from a file in rows and columns on the user's screen. File-wide commands can be used to make changes to the whole file or selected groups of records.

Links

Define the relationships between files, sorts, formats, screens, and views within the application. A link gives an application designer the flexibility to create several logical schemes for manipulation of physical files.

Menus

Control access security, function selection, and provide help for menu selections.

Messages

Provide a central repository for all user messages. Messages define not only the text but also validation rules and display location.

Help

Defines context-sensitive help, on-line help for menus, database maintenance, data entry, and messages.

System Dictionary

This is the dictionary for which Thoroughbred Dictionary-IV is named. A 4GL script or 3GL program can then use definitions from the dictionary.

At this point, it will help to define the meaning of the system dictionary. (You may also refer to the glossary in this manual for additional terms.)

The system dictionary is a central storehouse of structured information that can be shared by programs. It contains data definitions as well as other types of definitions and is more inclusive than a data dictionary.

Resource Sharing

One benefit of this design is the definitions in the system dictionary can be shared by any script or Basic program, which uses Dictionary-IV APIs.

Since data and system definitions are not contained in programs or scripts but are centrally located in the system dictionary, the programs and scripts can share those definitions.

The system dictionary provides the capability for shared resources. The data definitions and system definitions in the dictionary may be shared among any number of scripts or programs using the library of Dictionary-IV APIs. For example, five different scripts (or programs) may use the same help window because the help window definition is external to the scripts (or programs). This resource sharing between scripts (or programs) allows an efficient implementation of an application design.

Data Independence

Data independence is a result of defining the structure of data in a system dictionary, independent of the script (or program) that uses it. The system dictionary provides the capability of sharing the data definitions and significantly reducing maintenance. If you need to change a definition, you only have to do it once in the dictionary rather than many times in every application program that uses the definition.

Standardized User Interface

The user interface tools Thoroughbred Dictionary-IV provides can help to standardize the user interface design of your application and maintain consistency. You can design a standard user interface based upon your needs and implement it with the advanced development tools in Thoroughbred Dictionary-IV.

Because these are high-level tools, it is easier to produce a consistent user interface. These tools include free-form screen design, scroll-bar menus, windows, and views. How you combine these features to realize your design is up to you because Thoroughbred Dictionary-IV is very flexible.

Database

A database is an organized collection of information.

The telephone book is a database: the names, addresses, and telephone numbers are the data, and the names are organized alphabetically.

<u>LAST-NAME</u>	<u>FIRST-NAME</u>	<u>STREET</u>	<u>CITY</u>	<u>TELEPHONE</u>
Agassiz	Rick	21 Hill St.	Hot Springs	555-1889
Donato	Elyse	94 Red Rd.	Brookville	555-6391
Franklin	John	102 Main St.	Stover	555-3077
Sandler	Penny	22 W. Elm St.	Tulsa	555-0425

An ordinary dictionary is also a database. The words and definitions are the data, and the words are organized alphabetically.

A checkbook register, in which you record check payments, is another database: the date, check number, payee, payment amount, and account balance are the data, and the payments are organized by date and check number.

Thoroughbred Dictionary-IV stores the information in computer data files. A database consists of one or more related files.

In the preceding examples, each database contained a single file. A database can be as small or as large as you need it. The telephone database could contain additional files, depending on how much information you needed to control. This could be a directory for all the areas in the state, all the states in the country, or all the countries in the world.

Files, Records, Fields

One thing that makes a database so useful is that the information is organized. If the telephone book were not organized alphabetically, it would be a useless collection of information.

Organizing information requires that you use a structure so the information can be stored away and located later as is needed.

The Database - Files, Records, and Data Elements (Fields)

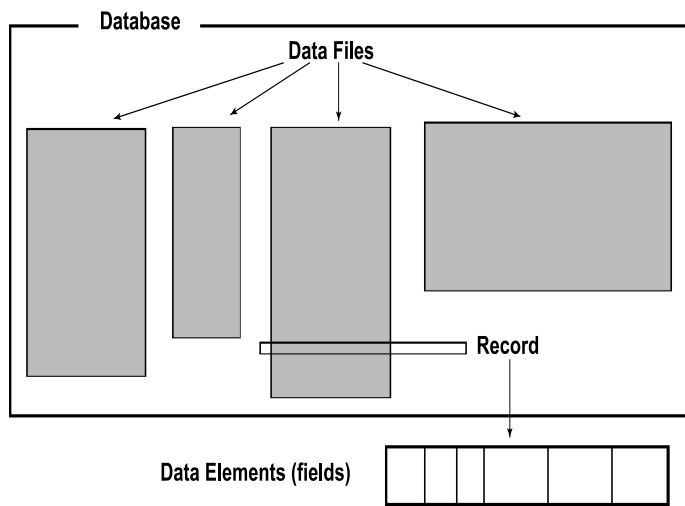

The database is the largest structure and can contain a number of related data files. We will discuss a small database with only one file.

The information in data files is organized into records. A record in the telephone file example would be the information for one person: last name, first name, street, city, and telephone number. Records are shown as rows.

The information in records is organized into data elements (fields). The data elements in the telephone file are the last name, first name, street, city, and telephone number. The data elements are shown as columns.

Data elements are usually, but not always, the smallest pieces of data in the organization.

<u>LAST-NAME</u>	<u>FIRST-NAME</u>	<u>STREET</u>	<u>CITY</u>	<u>TELEPHONE</u>
Agassiz	Rick	21 Hill St.	Hot Springs	555-1889
Donato	Elyse	94 Red Rd.	Brookville	555-6391
Franklin	John	102 Main St.	Stover	555-3077
Sandlar	Penny	22 W. Elm St.	Tulsa	555-0425

Below is a listing of some common synonyms.

Data File	Table, Relation
Record	Row, Tuple
Data Element	Field, Data Name, Column, Attribute

The information contained in each data element is referred to as a value. In the above example under the data element LAST-NAME we have the following values: Agassiz, Donato, Franklin, and Sandlar.

A record has a standard format so every record in the file has the same data elements. When you define a record, you define a format or the sequence of data elements in the record.

Data elements have certain characteristics, including a name and attributes such as size, the type of data it can hold, and whether it is used as a key to organize the file. The following topics provide a basic understanding of data elements.

Data Name and Size

When you create a data element, you give it a name and define the attributes. In the telephone file example, you might name one data element LAST-NAME and give it a size of 20. Values entered in this field cannot exceed 20 characters.

The following example is a 20-character field:

Robinson



Rosencrantz-Guildenstern

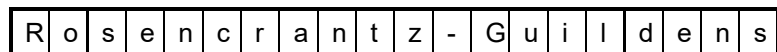

One reason for having a fixed size for data elements is so your system can find information very quickly. Since data elements have a fixed length, every record has a fixed length. No matter which record you access, the data elements can be found in the same position.

Types of Data

Information comes in many forms. A name is information and so is a word, a date, a number, or an amount of money. Each type of information is handled differently. A number can be added, subtracted, and multiplied with another number, but not so with a person's name.

<u>DATA-NAME</u>	<u>TYPE</u>	<u>DATA</u>
LAST-NAME	Text	Krupchezki
QTY-ON-HAND	Numbers	9301
ORDER-DATE	Dates	3/31/97
ORDER-TOTAL	Money	\$1,532.09
CUSTOMER-PHONE	Telephone	908-555-0302
EMPLOYEE-SS	Social Security	911-00-9019

Key Fields

Keys are data elements that help you to organize and locate information in a file. In the telephone file, the LAST-NAME is a key field because the file is in order by last name. If you want to locate Sam Jones in the telephone file, you look up Jones.

Keys help to identify the information for you. For most files, the system needs a special key so that it can identify information: the primary key.

Primary Keys

The primary key is a unique identifier for the record. If everyone in the telephone book had a different last name then you could use LAST-NAME as the primary key. Since this is not likely to be the case we must use some other method to uniquely identify each person.

If the people with the same last name all had different first names, then you could use the LAST-NAME plus the FIRST-NAME. In this case, the primary key would consist of two key fields: LAST-NAME and FIRST-NAME.

The primary key must contain a unique value that is the name of one and only one record. A social security number is a good example of a unique identifier.

Sometimes it is easier to invent a primary key. For example, you might create a data element named Code, which contains values from 0001 to 9999.

The primary key is often informally called the key of the file; however, the key may contain one or more primary key fields. In this example the company name is the primary key.

Primary Key Order: COMPANY Name				
<u>COMPANY</u>	<u>STREET</u>	<u>CITY</u>	<u>PHONE</u>	<u>BALANCE</u>
Boots & Saddles	21 Hill St.	Hot Springs	555-9561	\$203.00
Chamois by Kate	94 Red Rd.	Brookville	555-1352	\$174.59
Great Rider	102 Main St.	Stover	555-0880	\$962.05
Patently Leather	22 W. Elm St.	Tulsa	555-0465	\$564.23

In order by COMPANY name (ascending alphabetically).

The primary key is used to organize the file and to locate information. You may also use secondary keys to help you locate information that is not in the primary key.

Secondary Keys

Secondary keys allow you to access a file in an order other than primary key order. Unlike primary keys, secondary keys in Dictionary-IV do not have to be a unique identifier.

Secondary keys are also known as cross-indexes, or sorts. In this example BALANCE is the secondary key. The same data is listed in ascending order by BALANCE.

Secondary Key Order: BALANCE				
<u>COMPANY</u>	<u>STREET</u>	<u>CITY</u>	<u>PHONE</u>	<u>BALANCE</u>
Chamois by Kate	94 Red Rd.	Brookville	555-1352	\$174.59
Boots & Saddles	21 Hill St.	Hot Springs	555-9561	\$203.00
Patently Leather	22 W. Elm St.	Tulsa	555-0465	\$564.23
Great Rider	102 Main St.	Stover	555-0880	\$962.05

The same data in ascending order by BALANCE.

Database Management System

The need to control and use information in business is critical to success. A computerized database management system provides a powerful tool to manage and process information.

A database management system (DBMS) is used to create and maintain databases. It is used to create the database structure (the fields, records, and files), and maintain the information in the database by adding, deleting, or changing records (database maintenance).

When you create a file in a simple database, you must define the names and sizes of the fields in the record and define the fields that make up primary key of the record.

Creating a large database requires more preparation due to the greater complexity and need for efficiency. The technique of Structured Analysis and Design provides methods and procedures used to define a large database.

Once the database is set up you can add the information to it. Database maintenance allows you to add, change, or delete a record. You may also browse through the file (inquiry) and do other things such as count or copy records, and run reports.

Types of Data Files

Thoroughbred Dictionary-IV supports six types of data files:

- Direct
- Index
- Sort
- MSORT
- TISAM
- Text

The file type affects how records are stored and accessed and is determined by:

- Whether or not the record contains any primary key fields
- Whether or not the record contains any non-key fields
- What is defined in the file type field in the Link definition

The following chart shows how each file type is defined by the Format and Link.

		Key Indicator in Format		
		All Key	Some Key Fields	No Key Fields
Link File Type	I (Dictionary-IV)	Sort Files	Direct Files	Indexed Files
	M	MSORT	MSORT	N/A
	T	TISAM	TISAM	N/A
	U	N/A	N/A	Text Files

Direct

The direct file is used to store records that are to be accessed randomly and is the most commonly used file type. The direct file contains at least one primary key field and at least one non-key field. The records are sorted in order by the primary key values and can be accessed by these values. (The key to the file is the combination of all primary key fields.)

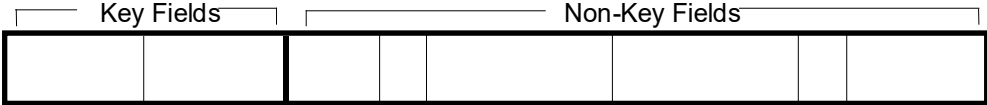

Index

The index file contains all non-key fields; it does not contain any primary key fields. The records are stored and accessed by record number, or index number, and are usually processed sequentially.

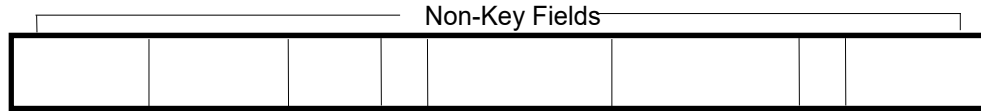

Sort

The sort file contains all primary key fields; it cannot contain any non-key fields. The records are accessed by the primary key, or a combination of the primary key fields, the same as a direct file.

NOTE: Thoroughbred Dictionary-IV automatically creates a sort file when you define a sort, or secondary key fields, for a data file. Sort fields allow you to access the file in an order other than the normal primary key order (or sequential order for index files). The Thoroughbred Dictionary-IV sort file stores secondary keys for the data file. Sort fields can be defined for all types of files.

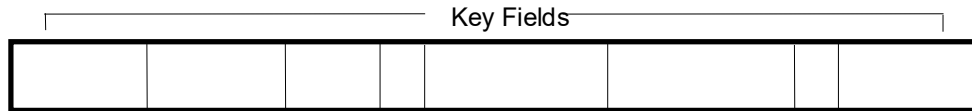

MSORT

An MSORT file is a multiple key data file. Each MSORT file may contain up to 16 sort key definitions, each containing up to 16 segment definitions, which contain field and offset positioning.

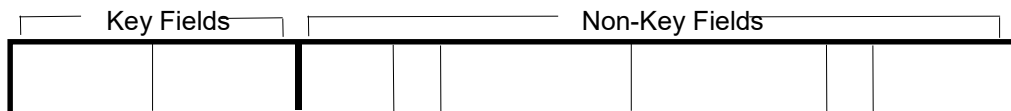

TISAM

A TISAM file is a Thoroughbred ISAM file (Indexed Sequential Access Method) that is structurally compatible with C-ISAM. It may have multiple key fields.

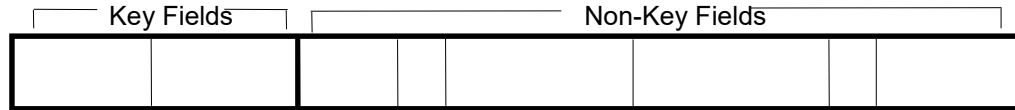

Text

A text file is a file containing straight text. File maintenance is not allowed on these files.

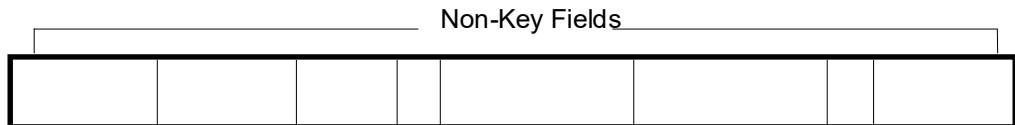

Software Conventions

The following sections describe Dictionary-IV software conventions.

Screen Navigation

If you are running VIP (Visual Image Presentation) Gateway for Windows, you may use your mouse to click and double-click on your selections as you normally would in the Windows environment.

If you are not running VIP Gateway for Windows, move through your application by using the **Arrow Keys**, **Tab Key**, **Function Keys**, and **Character Keys (0-9, A-Z, etc.)**.

Function Keys

Function keys having the same definition throughout all Thoroughbred products.

F4 Ends an operation or exits a function. The system allows you to save your addition or change or exit without saving.

F6 Displays on-line help in a window.

Function keys available from the Definition Name field in a Thoroughbred Class (Format, Screen, View, Link, etc.):

F1 Switches maintenance mode (add/change, delete, rename, and copy).

F2 Displays a lookup of definition names. You may select a definition from this list. If you type a full or partial name in the field and press **F2**, it will use that name (or partial name) to start the list. For example, if you want the list to start with the AR library, type **AR** and press **F2**.

F4 Displays the class selector. You may switch class.

Cursor Movement in the Field Edit

Left/Right Arrow

Moves the cursor one character left or right in the field. The cursor does not exit the field until you exit the edit mode.

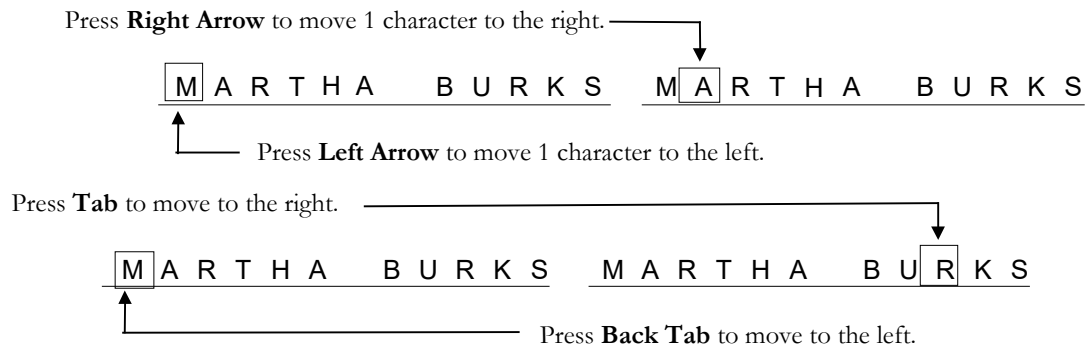

Tab/Back Tab

Moves the cursor half the width of the input window to the right or left in the field. The cursor does not exit the field until you exit the edit mode. In this example 23 characters is half the width of the window.

Home

If the cursor is on the first character in the field, the system moves it to the last position.

If the cursor is on any other character in the field, the system moves it to the first position.

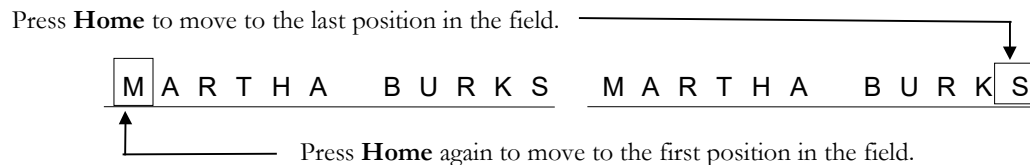

Character Insert/Delete

Press **Character Insert** in a field to insert characters in the field without typing over any characters.

Press **Character Delete** in a field to delete characters from the field.

Line Insert/Delete

Press **Line Insert** to insert a row in a file.

Press **Line Delete** to delete a row in a file.

Clear Line

Deletes all the characters from the field.

Press **Clear Line** to remove data from the highlighted character to the end of the field.

M A R T H A B U R K S M A R T H A B

Menu Types

In Dictionary-IV there are three different types of menus:

- Dictionary-IVPop-up
- Toggle (character-based applications)

Each is described below.

Dictionary-IV

A menu screen is used to display options. You must type a selection and press **Enter**. For example type **UTMENU10** and press **Enter** to see the following:

Dictionary-IV Control Menu

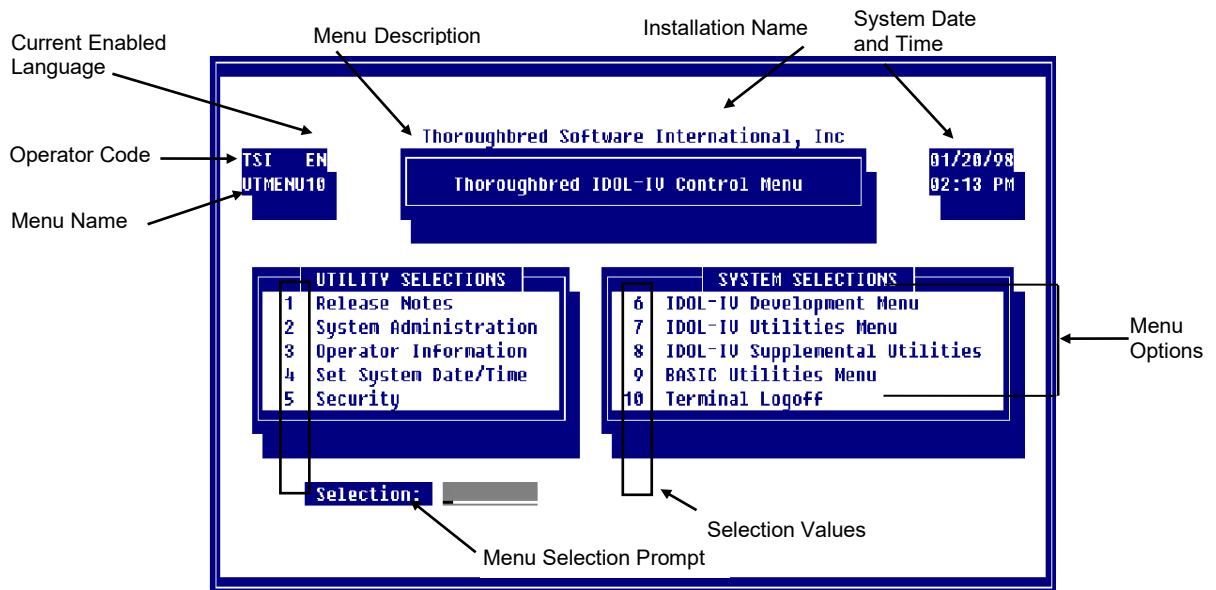

Pop-up

Pop-up menus allow you to scroll with a lightbar to highlight an item and press **Enter** to select it. For example press **F1** from any Dictionary-IV menu to see the following pop-up menu:

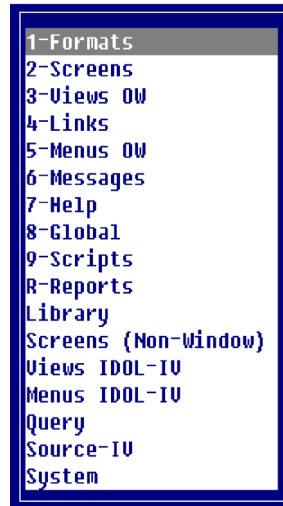

You may select options by:

- Typing the first character of the line and pressing **Enter**. To select Link definition type **4** and press **Enter**.
- Using the **Down** or **Up Arrow** keys to highlight the option and pressing **Enter**.
- Using the **Home** key to toggle between the first and last option in the list.
- Using the **Page Up** to move to the first option in the list, or **Page Down** to move to the last option in the list.

Toggle

Toggle menus are used in character-based applications and allow you to select one or more items on the menu. Press the **Space bar** or press the **Enter** key to toggle.

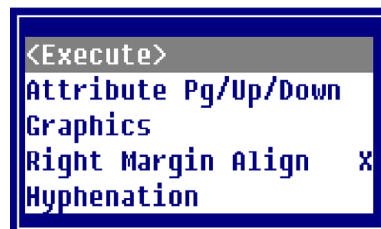

Exit and apply
Page Up/Down
Graphics mode
Right margin text
Hyphenation

You must select **<Execute>** to exit and save your changes. Press **F4** to exit without saving and enabling your selections.

Dictionary-IV Menu Selection Field Entry

From the Selection field on any Dictionary-IV menu you may type the option and press **Enter** to execute that option. You may also enter the following:

- F1** Displays the class pop-up menu for Definition Maintenance. This must be enabled through Installation Information. For more information see Installation Information in the Dictionary-IV Administrator Guide. Select the class to be maintained. For more information see pop-up menu in the previous section.
- F2** Displays the Screen/View database maintenance pop-up menu. Make a selection to perform database maintenance. This must be enabled through Installation Information. For information see Installation Information in the Dictionary-IV Administrator Guide.



Select **Screen** and press **Enter** to select Screen Maintenance.

Select **View** and press **Enter** to select View Maintenance.

- F3** Displays the Thoroughbred product pop-up menu. This must be enabled through Installation Information. For more information see Installation Information in the Dictionary-IV Administrator Guide.

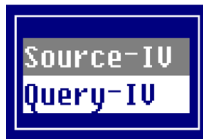

- F6** Displays on-line help for the menu.
- ?F6** Displays help for Menu Selections (**F1**, **F2**, ;**menu-name**, etc.).
- # F6** Displays on-line help for the specified menu selection. For example, type **1** and press **F6** to view the on-line help for option 1.
- F7** Allows the selection of a language code. This must be enabled through Installation Information. For more information see Installation Information in the Dictionary-IV Administrator Guide.
- F10** Displays a lookup of menu names. This is the same typing **DM** and pressing **Enter**.
- Ctrl-P** Activates Desk Services (Hotkey Menu). For more information, see Desk Services Hotkey Menu in the Dictionary-IV Administrator Guide.

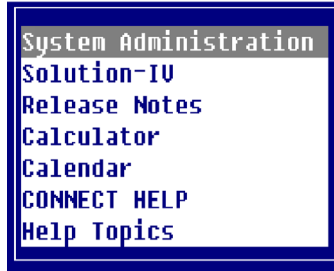

- .query** Type . and the query name to run the specified query.
- .report** Type . and the report name to run the specified report.
- ;menu** Type ; and the menu name to display the specified menu.
- /program** Type / and the program name to run the specified program or script.
- :program** Type : and the program name to run the specified program or script.
- DBM** Displays the Screen/View Database Maintenance pop-up menu (see **F2**). This must be enabled through Installation Information. For more information, see Installation Information in the Dictionary-IV Administrator Guide.
- DM** Displays a lookup of menu names (see **F10**).

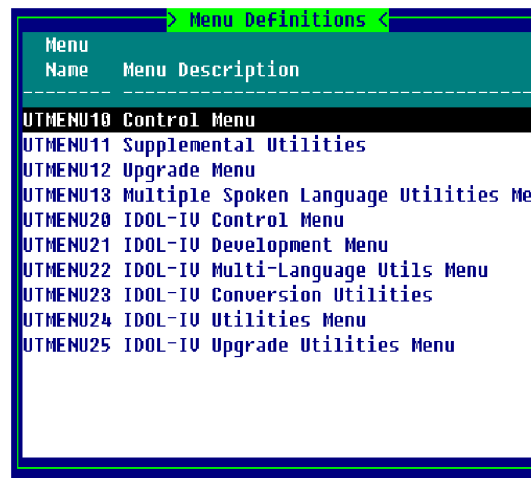

- ID** Displays the Dictionary-IV Development Menu.
- LOF** Logs off and returns to the Operator Code prompt.
- MAIN** Returns to the login menu and clears the menu trail. For more information on defining this menu see Installation Information in the Dictionary-IV Administrator Guide.
- MRM** Allows you to perform database maintenance on the selected View, Link, or Format.
- MS** Accesses the internal mail system. For more information, see Mail System in the Dictionary-IV Administrator Guide.

- SRM** Allows you to perform database maintenance on the selected Screen, Link, or Format.
- TQ** Runs Query-IV.
- TS** Runs Source-IV.

Dictionary-IV Menu Trails

A menu trail is created as you move from menu to menu in an application. For example, selecting the Dictionary-IV Development Menu from the Dictionary-IV Control Menu and the Dictionary-IV Utilities Menu from here sets up a menu trail. Pressing the **F4** key always takes you to the previous menu in the menu trail.

Menu Processing

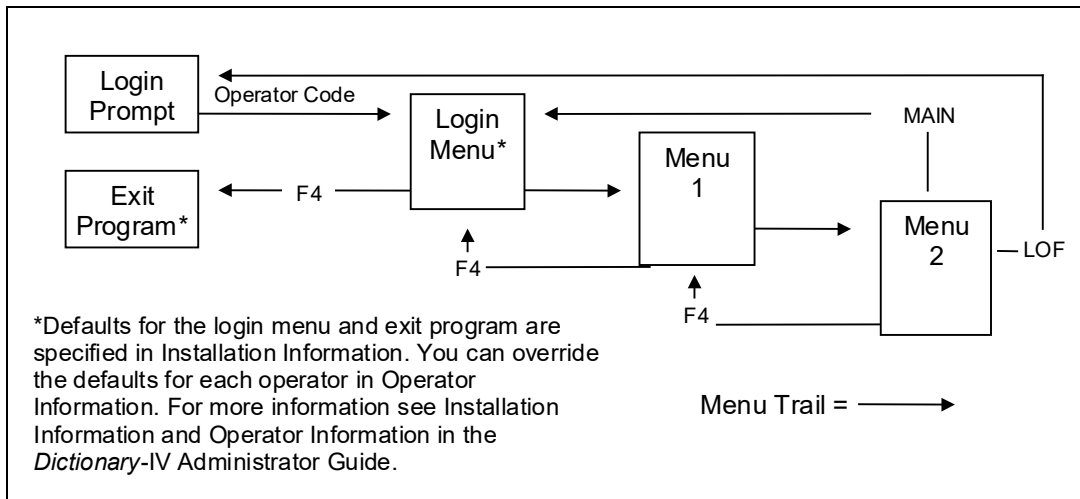

Select Messages

A special type of input message called a select message is used to display multiple selections through which the operator can scroll the cursor and make a selection.

Select Messages

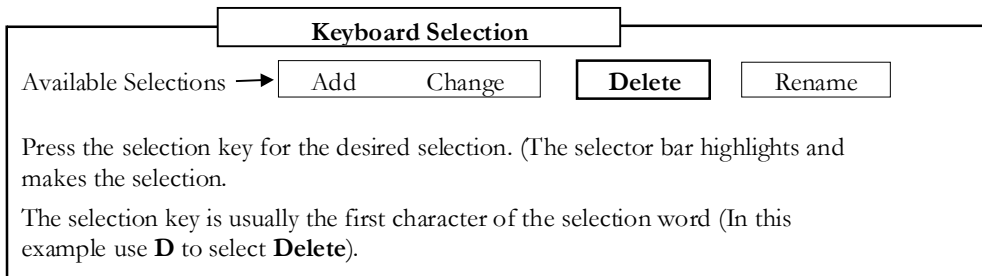
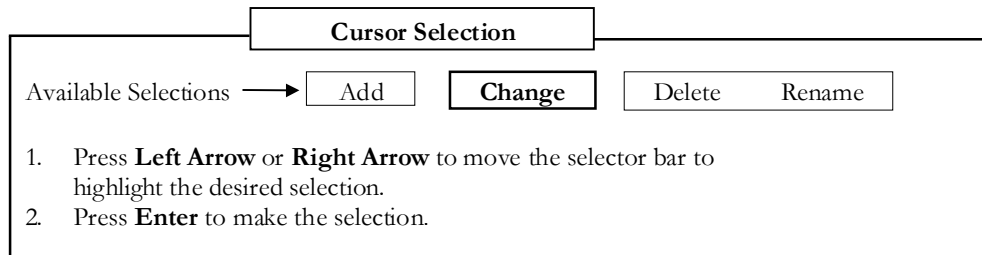
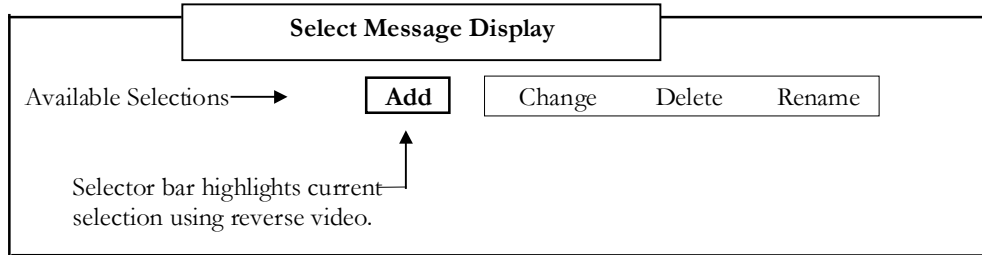

Printing

If you select a print option or press **F16**, Dictionary-IV prompts:

Select Printer (xx, x1x1, x2x2) :

XX, X1X1, X2X2 refers to the names of the printers you added during Printer Assignment. For more information see Printer Table Maintenance and Printer Assignment in the Dictionary-IV Administrator Guide.

Type the printer name and press **Enter**. You can press **F1** for a lookup of printer names. Following the Select Printer prompt, the system may display a message **Current Window (W) or Entire Screen (S)**: Enter **W** to print only the current window (e.g. View or Input Screen) or **S** to print all data on the screen

F1 Lookup Printer Names

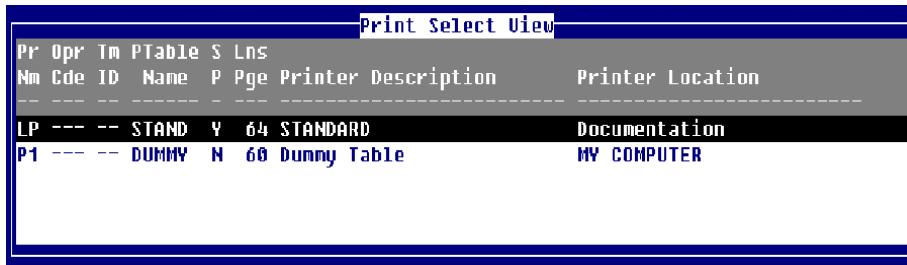

Pr Nm	Opr Cde	Tm ID	P Table Name	S	Ln Pge	Printer Description	Printer Location
LP	---	--	STAND	Y	64	STANDARD	Documentation
P1	---	--	DUMMY	N	60	Dummy Table	MY COMPUTER

The following values are defined in **Printer Assignment**. For more information see Printer Assignment in the Dictionary-IV Administrator Guide.

Pr Nm

Printer Name (LP, P1, P2, etc.).

Opr Cde

Operator Code that has this printer open.

Tm ID

Terminal ID that has this printer open.

P Table Name

Printer Table Name.

SP

Spooled (yes/no). Select **Yes** to send the output to a print spooler.

Ln Page

Number of lines per page.

Common Syntax Elements

Some commands in this manual use common syntax elements, which are explained in this section.

Expressions

An expression is two or more elements, consisting of constants, data names, variables, or functions that interact with operators to form a new value.

An expression can be used in a screen data field (formula), and in conditions.

Operators in Expressions

+	addition or string concatenation
-	subtraction
*	multiplication
/	division
^ or **	exponentiation
()	grouping

Numeric expressions are evaluated according to the normal priority convention (grouping, exponentiation, multiplication/division, addition/subtraction).

Logical Conditions

A logical condition is two or more values, consisting of constants, data names, variables, functions, or expressions that interact with relational or logical operators to form either a true or false result.

Operators in Conditions

=	equal to
>	greater than
<	less than
>= or =>	greater than or equal to
<= or =<	less than or equal to
<> or ><	not equal to
()	grouping
AND	logical AND (both true)
LIKE	search for a match using partial values
OR	logical OR (either true)

String

A string is a connected sequence of characters treated as one piece of data.

Substring

Substrings can be used in screen data fields, sort definitions, and view commands. They allow you to specify a portion of the original value in a data name.

- Substrings can only be used with alphanumeric data elements.
- Substrings cannot be used with a multiple occurrence data element.

The syntax is as follows:

string-elmt [(start, length)]

string-elmt is an alphanumeric data name.
start is the starting position for the substring.
length is the number of characters of the substring.

Examples:

CUST-NAME(1,5)

This specifies the first 5 characters of the CUST-NAME data element.

ITEM-CODE(1)

This syntax is valid only when ITEM-CODE is a multiple occurrence, and it does not specify a substring. This specifies the entire value of the first occurrence in a multiple occurrence data element. For more information see Data Element and Multiple Occurrence in the Dictionary-IV Developer Guide.

Masks (Output Formats)

A mask specifies the format in which numeric data is displayed or printed. A mask can be used in screen data fields, reports, queries, and scripts.

Masks allow you to specify the same output format regardless of the size of the number. They also allow you to output financial symbols and characters (for example to format 563204 as \$5,632.04-), and to retain insignificant zeros (for example to output 1 as 1.00).

Syntax

The syntax is as follows:

num-elmt: "mask"

num-elmt is a numeric data name, formula, or multiple occurrences.
mask is one or more mask characters.

Mask Characters

Each digit in the numeric value that is output must match up with a mask character. Mask characters determine the output. You can specify more mask characters than there are digits in the numeric value.

An insignificant zero is a leading or trailing zero. A floating character is output at the rightmost leading zero.

- 0** Outputs a digit from 0 to 9. When the digit is an insignificant zero, it outputs a 0.
- #** Outputs a digit from 0 to 9. When the digit is an insignificant zero, it outputs a space.
- .** Outputs a decimal point between digits. If the number is 0 and 0 is not used in the mask, it outputs a space.

,	Outputs a comma between digits if the digit to the left is a significant digit; it can only be used to the left of the decimal point.
\$	Outputs a dollar sign.
*	Outputs an asterisk when the digit is a leading zero.
□	Outputs a minus sign if the number is negative, or a space if the number is positive. This mask character can be placed at the left or right of the mask. If placed to the left, it is a floating character.
+	Outputs a plus sign if the number is positive, a minus sign if the number is negative, or a space if the number is zero. This mask character can be placed at the left or right of the mask. If placed to the left, it is a floating character.
CR	Outputs a CR (to indicate a credit) if the number is negative, or 2 spaces if the number is positive. This mask character must be placed at the right of the mask.
DR	Outputs DR (to indicate a debit) if the number is positive, a CR if the number is negative, or a space if the number is 0. This mask character must be placed at the right of the mask.
(Outputs a left parenthesis if the number is negative, or a space if the number is 0 or positive. This mask character must be placed at the left of the mask.
)	Outputs a right parenthesis if the number is negative, or a space if the number is 0 or positive. This mask character must be placed at the right of the mask.
B	Outputs a space.
????	Outputs any characters other than the mask characters and places them in the specified position.

Documentation Conventions

The following sections describe Dictionary-IV documentation conventions.

Keyboard Designations

Keys on the keyboard are identified in bold type. For example, Press **Enter** to make your selection or press **F4** to exit.

The documentation refers to **Line-Insert Key**, **Line-Delete Key**, **End-of-Line Key**, etc. These are the functions of particular keys. Please refer to your keyboard documentation to determine the specific key that performs this function for you.

Prompts and Messages

Software prompts and messages are indented and shown in bold type. For example:

**RETURN-Select, F4-END
Save Changes (Y/N)**

Prompts and messages may refer to Return,<CR>, or Carriage Return. This manual refers to these as the **Enter** key.

Responses

Options you may select or information you must type appear in bold type. It must be entered exactly as shown. For example, Type **John Smith** and press **Enter**.

Notational Symbols

Syntax appears in a bold non-proportional font to better display spaces and punctuation. Elements of the syntax are always explained directly below. The following conventions are used in command formats throughout the Thoroughbred product line.

Command Syntax

CONNECT VIEW {view-name-1} [[view-name-2] ...]

<u>Notational Symbol</u>	<u>Description</u>
(BOLD FACE/UPPERCASE)	CONNECT VIEW Commands or keywords you must type exactly as shown. <i>Example: CONNECT VIEW UTVCUST</i> You must type CONNECT VIEW including the space.
<i>Italic Face</i>	<i>view-name-1</i> Information you must supply. <i>Example: CONNECT VIEW UTVCUST</i> You supply the view name UTVCUST. In most cases, lowercase italics denotes values that accept uppercase or lowercase characters.
Braces { }	{view-name-1} [[view-name-2]...] You must select one of the values enclosed by the braces. <i>Example: {UTVCUST1} [[UTVCUST2]...]</i> You must supply the view name UTVCUST1.
Brackets []	You can select one of the options enclosed by the brackets; none of the enclosed values is required. <i>Example: {UTVCUST1} [[UTVCUST2]...]</i> You must supply the view name UTVCUST1. You may also supply the optional view name UTVCUST2.

Ellipsis ... You can repeat the word or clause that immediately precedes the ellipsis.
Example: {UTVCUST1} [[UTVCUST2]...
 You must supply the view name UTVCUST1. You may also supply the optional view names UTVCUST2, UTVCUST3, UTVCUSTX. X represents any existing view name in the library.

Other Notational Symbols

<u>Notational Symbol</u>	<u>Description</u>
Vertical Bar	<p>Option-1 Option-2 Option-3</p> <p>Piping separates options. One vertical bar separates options; two vertical bars separate three options. You select only one of the options. <i>Example:</i> Add Change Delete You may select the Add, Change, or Delete option.</p>
<u>Underscores</u> or <i>UPPERCASE ITALICS</i>	<p>Either a default in a command description or display default in a screen image. <i>Example:</i> Add <u>Change</u> Delete You may select the Add, Change, or Delete option. The Change option is the default value.</p>

For More Information

... about using each Dictionary-IV product, refer to the individual reference manual (Query-IV, Report-IV, Script-IV, and Source-IV Reference manuals).

... about Thoroughbred Basic, refer to the Thoroughbred Basic Reference Manual.

... about Basic Utilities refer to the Thoroughbred Basic Utilities Reference Manual.

... about defining terminals and printers refer to the Thoroughbred Basic Customization and Tuning Guide.

DATABASE MAINTENANCE

Database Maintenance is a process of adding, changing, or deleting records in a database. This section explains the general concepts of database maintenance. To understand how to perform database maintenance in Dictionary-IV CONNECT SCREEN, and CONNECT VIEW, you may also use the Dictionary-IV Quick Database Lesson for additional assistance.

Types of Database Maintenance

Thoroughbred Dictionary-IV provides two types of database maintenance:

- CONNECT SCREEN (Single-Record Maintenance)
- CONNECT VIEW (Multi-Record Maintenance)

CONNECT SCREEN

Edits or creates a single record at a time, using a data entry screen. For more information see Screen Definition in the Dictionary-IV Developer Guide.

CONNECT VIEW

Edits or creates multiple records using a view of the data file. For more information, see View Definition in the Dictionary-IV Developer Guide.

A view displays multiple records at one time. Each record may have one or more fields.

Example of a Dictionary-IV View

<u>Record #</u>	<u>Field 1</u>	<u>Field 2</u>	<u>Field 3</u>
1	Red	Oriole	Five
2	Purple	Cat	One Hundred
3	Orange	Snake	Thirty Two
4	Blue	Fish	Eleven

Both CONNECT SCREEN and CONNECT VIEW can be performed on the same data file.

Creating a Database

You must create a format for the database. After creating the format the first time you select screen or view database maintenance, the system prompts you through the creation of a new data file.

It then generates a default data entry screen (or view) and link.

NOTE: Although a default view is generated with the creation of a data file, it cannot be used to maintain data records until you enable change key and change data in View Maintenance. For more information see View Definition in the Dictionary-IV Developer Guide.

Create the Definitions

The following are components of database maintenance:

Format

The format identifies the data elements in the file. You must create the format before you can use database maintenance. This is the minimum requirement to perform database maintenance. Dictionary-IV creates necessary default definitions required to perform database maintenance. For more information, see Format Definition in the Dictionary-IV Developer Guide.

Data File

This is the file that stores the data. Database maintenance can use an existing data file or one that it creates. From the information in Format and Link definition, database maintenance determines the type of data file (key, index, or sort), the default record size, the number of records, and the directory where the file is to be located. For more information see Format and Link Definitions in the Dictionary-IV Developer Guide.

Screen or View

These definitions collect the data. You may perform database maintenance using a custom screen or view that you create, or a default screen or view that database maintenance creates. For more information see Screen and View Definitions in the Dictionary-IV Developer Guide.

Link

The Link is the Dictionary-IV interface to a data file, sort definitions, security, and the Screen or View definition. Database Maintenance can use the Link you define or one that database maintenance creates. For more information see Link Definition in the Dictionary-IV Developer Guide.

Create the Data File

If this is the first time you are performing Screen (or View) Maintenance using the Screen (or View), Link, or Format name, the system displays the following:

Create Data File - CONNECT SCREEN and CONNECT VIEW

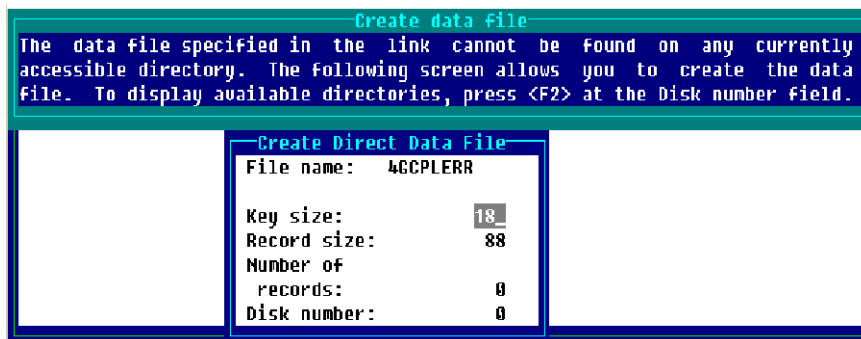

```

Create data file
The data file specified in the link cannot be found on any currently
accessible directory. The following screen allows you to create the data
file. To display available directories, press <F2> at the Disk number field.

Create Direct Data File
File name: 4GCPLERR
Key size: 18
Record size: 88
Number of
records: 0
Disk number: 0

```

Below are the descriptions of the Create Direct Data File fields:

File name

Displays the name of the data file.

Key size

Displays the key size. The system calculates this from the Format Definition. If the file is an Index file, the key size is not applicable. The range for the key size is system dependent and can normally be from 4 to 144. When text fields are defined in the Format Definition and the file type is Direct, the key size is automatically increased by 4.

Press **Enter** to accept the default value.

Record size

Displays the record size in bytes. The system calculates the record size from the Format Definition. You may increase the size. The valid range is from 4 to 32767 bytes.

The minimum record size for auto-expanding Direct files is 6 bytes. Smaller record sizes are adjusted automatically.

Press **Enter** to accept the default value.

Number of records

The system displays a default value. You may enter a value from 0 to 2,147,483,647.

Auto-expanding Direct and Sort files are created by specifying 0 records. This is not valid for Index files (no key fields). The minimum record size for auto-expanding Direct files is 6 bytes. Smaller record sizes are adjusted automatically.

Static files are created by entering a value greater than 0. They are expanded by Dictionary-IV when full.

Press **Enter** to accept the default value.

Disk Number/Directory Number

The system displays the disk where Dictionary-IV is installed. You may enter a valid logical disk ID (0 to 9 or A to Z), representing the directory where the file will be created. The system displays a message if the disk is currently unavailable.

Press **Enter** to accept the default value.

With the last entry the system prompts:

Is the displayed information correct?

Select one of the following:

Y Creates the data file.

N Returns to the previous screen.

The system creates and displays a default screen (or default view if you were performing View Maintenance) and you may begin database maintenance.

Create a Default Screen

If you select a database that does not have a custom screen, the system generates a default screen for this maintenance session only.

The data elements appear in the order in which they appear in Format Definition. For more information see Format and Screen definitions in the Dictionary-IV Developer Guide.

Create a Default View

If you select a database that does not have a custom view, the system generates a default view.

Sample Default View (CONNECT VIEW)

Code	Customer Name	Rep	YTD Sales
			.00
0001	Warren Baseball Club	003	1618.55
0002	Lakewood Little League	001	2388.50
0003	Southside Raiders	004	1153.65
0004	Blue Diamond Baseball	002	1980.50
0005	Team Sports	001	2831.65

NOTE: You cannot use the default view for database maintenance until the Change Key and Change Data flags in View Definition are set to **Y** (yes).

The data elements appear in the order in which they appear in Format Definition. For more information see Format and View definitions in the Dictionary-IV Developer Guide.

Using Definition Linkage

Dictionary-IV stores definitions independently in the system dictionary. Database linkage allows you to share database definitions.

You may achieve the linkage in one of two ways:

- Reference a Link Definition. This Link ties together supporting data file(s), Format definitions, Screen definitions, and View definitions.
- Reference a non-Link Definition.

Definition Pointers

To create this definition linkage, Dictionary-IV uses definition pointers. They are the fields in a Class definition that point to another Class definition. Screens, Views, and Links all contain definition pointers.

A brief description follows. For more information see Screen, View, and Link Definition in the Dictionary-IV Developer Guide.

Screen Definition

The Screen Definition points to a Link or a Format definition from the Link/Format Name field.

View Definition

The View Definition points to a Link or a Format definition from the Link/Format Name field.

Link Definition

The Link Definition determines the database. It contains several pointers because this is a primary function of the Link. The Link points to a Format Definition and a data file. It may also point to a Screen and View user interface for the database.

Database Selection Rules

When you select a Database Maintenance option from the Dictionary-IV Development Menu, the system displays the following:

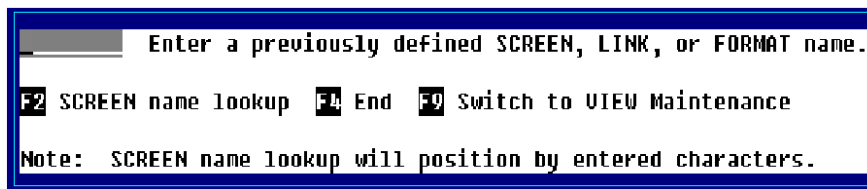

Dictionary-IV selects the database according to the following rules:

- It first determines the type of definition that has been entered by first checking Screens (or Views), second checking Links, and third checking Formats.
- It then determines whether the definition exists.

This priority is reflected in the database maintenance prompts listed above.

At the prompt you may enter the following information:

Screen/View Name

The database selection process is parallel for Screen and View database maintenance. Although the following explanation refers to Screens, it also applies to views.

If the name matches an existing Screen name, that Screen definition is displayed for file maintenance. Multiple Screens can share the same database. More than one Screen can point to the same Link or Format, providing multiple user interfaces to the same database.

Example: An employee address Screen and a pay rate Screen both interface to the employee file.

The system attempts to read a Link Definition using the Link/Format Name specified in the Screen Definition. If a Link does not exist the system attempts to read a Format Definition using the same Link/Format Name.

If database linkage is defined, the specified Screen is used for the interface.

Link Name

When the entered name does not match a Screen name, but matches a Link name, the Screen specified in the Link Definition is used for file maintenance. This allows multiple databases to share the same Screen and the same Format definitions. More than one Link can point to the same Screen and Format definition, providing a common user interface to multiple related databases.

NOTE: If the Link definition does not point to a valid Screen, the system generates a default Screen for the user interface.

For example, a prospect maintenance Screen can interface to both a hot prospect file and a cold prospect file.

Format Name

When the entered name does not match a Link or a Screen definition, but matches a Format Definition, the default Screen is generated for file maintenance.

This option provides a quick way to create a database. Once you create a Format Definition, enter this name at Screen (or View) Maintenance. The system creates the necessary definitions using the same name as the Format. It creates a Link Definition, creates a data file, and provides a default Screen.

NOTE: This condition is always temporary because the next time the Format name is entered, it will match the Link name.

When you press **F2** for a lookup of Screen or View Names, the system displays a header (view) similar to the following:

Screen Name	Screen Title	Link Name	Created Date	LastChng Date	Lchnng Time
4GCLSEL	4GL - Compile List Select	4GCPSEL	03/25/85	11/03/97	18:13
4GCPSEL	4GL - Compile Select	4GCPSEL	03/25/85	05/22/97	21:27
4GDIRDET	4GL Script list	4GPGMHDR	07/28/87	06/24/96	17:13
4GDIRHDR	4GL - Program Library Listing	IDLIBR	02/19/86	02/06/96	12:28
4GDISEL	4GL - Library List Select	4GCPSEL	03/25/85	02/06/96	12:28

Maintenance within the header (view)

The maintenance options within the header (view) are described in the following sections:

Add

To add a definition press **Line Insert** from the header (view). The system inserts a blank line. Enter a definition name from three through eight characters long. If you enter a name and the library does not exist, you will be allowed to create the library automatically.

If you enter a new name, you are adding a new definition. If you enter an existing name, the system will display the following message

A record already exists with the key used to define the record being added to the file. Add request will be denied.

Change

To make changes to a definition from the Header (view) select the definition and highlight the field to be changed, type over the information displayed. If you make changes to the definition name the system displays a window showing the definition name and the name the definition is being changed to. The system then displays a pop-up menu with the option to Cancel, Copy, or Rename.

To make changes to the definition press **F1-Edit**, make the changes, and press **F4** to save the definition or changes to the definition. The following prompt is displayed:

Save report modifications (Y/N)?

Select one of the following:

Y Saves the definition.

N Does not save the definition.

Delete

To delete a definition from the Header (view), highlight the definition name and press **Line Delete**. The following prompt is displayed:

Delete Record (Y/N)?

Select one of the following:

Y Deletes the definition.

N Keeps the definition.

Rename

To rename a definition from the Header (view), highlight the definition name and type the new name over the existing name. The system will display a window showing the definition name and the name the definition is being renamed to. The system also displays a pop-up menu with the option to Cancel, Copy, or Rename. Select **Rename** to rename the definition.

When you rename a definition, it does not have to remain in the same library. If you rename it to a library that does not exist, you can create the library automatically.

Copy

To copy a definition, select the definition name from the Header (view) and type the name to copy to over the existing text. The system will display a window showing the definition name and the name the definition is being copied to. The system also displays a pop-up menu with the option to Cancel, Copy, or Rename. Selecting **Copy** will copy the definition with the new name and the original definition will still exist.

When you copy the definition, it does not have to remain in the same library. If you copy it to a library that does not exist, you can create the library automatically.

Using Multiple Occurrence Fields

If the Format Definition specifies a data name with multiple occurrences, data entry to the multiple occurrence field operates as follows:

- The multiple occurrence field displays as a single field in the Screen or View. The field serves as a window in which each occurrence can be accessed. When you enter the field, the system accesses the first occurrence. You can move from occurrence to occurrence the same way that you move from field to field, by pressing **Enter**, **Up Arrow**, or **Down Arrow**.
- The current occurrence number displays at the top right of the Screen or View.

NOTE: A single, specific occurrence of a multiple occurrence field can be specified in a custom Screen and it will operate as a normal field. For more information see Screen Definition in the Dictionary-IV Developer Guide.

For more information, see CONNECT SCREEN, and CONNECT VIEW.

Creating Database Security

You may include a password in the Link or View definition to access to the database. You must then enter the password before performing database maintenance.

You may also restrict access by terminal or operator code in the definition. For more information see Link Definition in the Dictionary-IV Developer Guide.

NOTE: System security must be active for these features to work.

Expanding Database Files-Automatically

If a static sized data file becomes full during database maintenance, Dictionary-IV automatically expands it based on the number of records in the file.

Database Expansion

<u>File Size</u>	<u>Expanded By</u>
1-99	250 Records
100-999	200%
1,000-19,999	30%
20,000 and up	15%

If the system attempts to expand a file that is being used by another operator, the following error message displays:

File is Full! Can't Expand (BUSY). <Return>=Retry, <F4>=Emergency Abort

All other operators should exit the file.

Press **Enter** to retry the expansion. The system automatically retries the expansion every 60 seconds unless the operator presses **F4**.

Using the File Suffix

The file suffix indicator is the @ character and can be specified anywhere in the Data, Sort, or Text file names in the Link Definition or in Script-IV.

If the file suffix indicator is used in a Link and that Link is used for database maintenance, database maintenance will substitute a file suffix value for the file indicator. The resulting file name will be used.

To assign a file suffix value, you must use Script-IV. Write a script that sets the FILE-SUFFIX variable to the desired file suffix value. When each operator runs the script, the file suffix value is assigned to the operator. If the file suffix value is null or spaces, the file suffix indicator is dropped from the file name.

NOTE: The file suffix value is stored in the operator record until it reset by another assignment.

For more information see FILE-SUFFIX in the Script-IV Language Reference.

CONNECT SCREEN

CONNECT SCREEN enables you to connect to a screen definition, display the screen, and initiate screen maintenance. If there is no data file, the system prompts for creation of the data file.

Screen definitions are also used by Script-IV INPUT SCREEN, Script-IV PRINT SCREEN, and 8INPUT. They require a Format and a Link. For more information see Format Definition and Link Definition in the Dictionary-IV Developer Guide.

For more information, see the Database Maintenance section in this manual. Also see Screen Definition in the Dictionary-IV Developer Guide.

Selecting CONNECT SCREEN

You can execute CONNECT SCREEN by selecting **S Screen (CONNECT SCREEN)** from the Dictionary-IV Development Menu or by pressing **F2** from any Dictionary-IV menu and selecting **Screen**, the system displays the following:

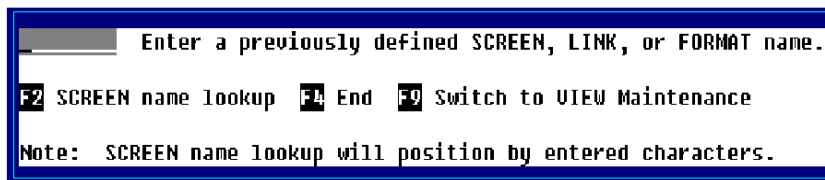

You can also execute CONNECT SCREEN from a pop-up menu by pressing **F1** and adding the CONNECT SCREEN to the pop-up menu.

The system displays a window similar to the following:

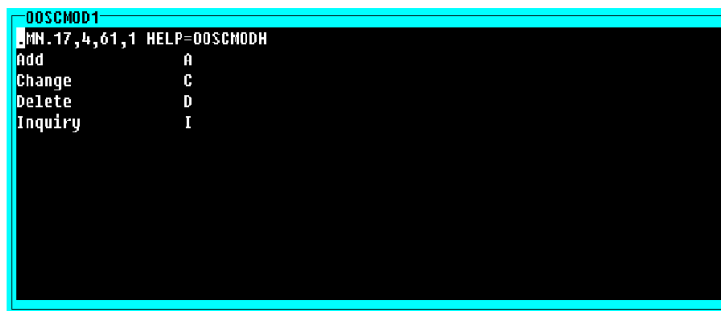

For information on executing CONNECT SCREEN from a script, see the Script-IV Language Reference.

Performing CONNECT SCREEN

You can initiate CONNECT SCREEN by selecting **S Screen (CONNECT SCREEN)** from the Dictionary-IV Development Menu or pressing **F2** from any Dictionary-IV menu and selecting **Screen**. The system allows you to enter a screen name. Once a screen name is entered the following pop-up menu is displayed.

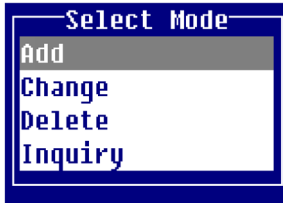

Maintenance Modes

You may select a maintenance mode (Add, Change, Delete, or Inquiry).

Select one of the following options:

Add

This mode allows you to add a record to the file. This is the default.

If you try to add a record that already exists, the system switches to the change mode. When data entry is complete the system prompts:

**Add this record? Yes-Add record No-Do not add record
<F4> Make corrections.**

Select one of the following:

Y Adds the record to the file.

N Does not add the record to the file.

F4 Returns to the record. You may make corrections.

Change

This mode allows you to edit a record in the file. It functions as the add mode except the change mode does not switch to the add mode if a record does not exist.

If you enter an existing file you can select the next record in the file by pressing the **Down Arrow** key at the last key field on the screen. You can also select the previous record by pressing the **Up Arrow** key at the first key field on the screen.

The system prompts:

Key specified not on file, <CR> to continue.

When the changes are complete the system prompts:

**Save Changes? Yes-Update record No-Do not update record
<F4>-Make Corrections.**

Select one of the following:

Y Saves the changes.

N Does not save the changes.

F4 Returns to the record. You may make corrections.

Delete

This mode allows you to delete a record from the file. If you enter an existing file, you can select the next record in the file by pressing the **Down Arrow** key at the last key field on the screen. You can also select the previous record by pressing the **Up Arrow** key at the first key field on the screen.

Type the key to the record and press **Enter**. If the system finds the record, the system prompts:

Delete record?

Select one of the following:

Y Deletes the record from the file.

N Does not delete the record, but allows you to continue selecting records to delete.

Inquiry

Type the key of an existing record to display and press **Enter**. This mode is for display only. If you enter an existing file, you can select the next record in the file by pressing the **Down Arrow** key at the last key field on the screen. You can also select the previous record by pressing the **Up Arrow** key at the first key field on the screen.

Key Value Test

Once you select a maintenance mode, the system positions the cursor at the first key field. When you enter a key value, the system checks to see if it exists.

Primary Keys

To select a record using the primary key value type the primary key value and press **Enter**.

Press **Down/Up Arrow** in the primary key field to get the next/previous record in the file. Press **Enter** to select the record.

Press **Page Down/Up** to go to the last/first record in the file. Press **Enter** to select the record.

Secondary Keys

To select a record using the existing sorts press **F5**. If secondary keys exist you may select one from the lookup sort view.

For more information see **F5 Sorts**.

Key Test for CONNECT SCREEN

Key Test Result \ Mode	Add	Change	Delete	Inquiry
Key exists:	Switches to change mode.	Locates record and allows edit.	Displays record and prompts to delete.	Displays record.
Key does not exist:	Allows you to add the record.	Displays a "does not exist" message.	Displays a "does not exist" message.	Displays a "does not exist" message.

Quick Key Reference

You may perform the following functions.

Key Description

- F1** Changes maintenance mode.
- F3** Prints the record. For more information see Software Conventions.
- F4** Exits the record. For more information see Software Conventions.
- F5** Selects a sort. Sorts are defined in Link definition. For more information see F5 Sorts. Also see Link Definition in the Dictionary-IV Developer Guide.
- F6** Displays on-line help if help is defined for the data element (key field). For more information see Software Conventions.
- F9** Switches to View maintenance.
- F10** Goes to a field. A lookup of available field names appears. Select the field in the lookup and press **Enter**.

Cursor Movement

In a key field

The following keys have special actions in key fields:

<u>Key</u>	<u>Description</u>
Page Down	Moves to the last/first record in the file.
Page Up	Moves to the first record in the file.
Down Arrow	Moves to the next record in the file.
Up Arrow	Moves to the previous record in the file.

In all fields

The following keys perform the same action in key and data fields:

<u>Key</u>	<u>Description</u>
Right Arrow	Moves one character to the right in the field.
Left Arrow	Moves one character to the left in the field.
Tab	Moves ½ the length of the field right.
Back Tab	Moves ½ the length of the field left.
Home	Moves to the last/first character in the field.

In a data field

The following keys have special actions in data fields:

<u>Key</u>	<u>Description</u>
Page Down	Moves between the last data field in the record.
Page Up	Moves to the first data field in the record.
Down Arrow	Moves to the next field in the record. The entry order is determined by the Order specified in Screen definition. For more information see Screen Definition in the Dictionary-IV Developer Guide.
Up Arrow	Moves to the previous field in the record. The entry order is determined by the Order specified in Screen definition. For more information see Screen Definition in the Dictionary-IV Developer Guide.
Enter	Accepts the data and moves the lightbar to the next entry field. The entry order is determined by Element Order specified in Screen definition. For more information see Screen Definition in the Dictionary-IV Developer Guide.

F5 Sorts

You can use sorts to access specific records in CONNECT SCREEN.

NOTE: The number of lines in the F5 Sort Window is 100. The size of the F5 Sort Window is adjustable based on the number of sorts defined.

Selecting a Sort

Press **F5** and the system displays a listing of defined sorts. Select the sort and press **Enter**.

NOTE: You must have the sort defined in Link Definition. For more information see Link Definition in the Dictionary-IV Developer Guide.

The system prompts:

Enter secondary key value:

If, for example, you are working with a customer database, you may now process the records for your customers by city or you edit customer records in a specific city by typing the name of the city.

The following options are available at this prompt:

- Type the secondary key value and press **Enter**. The system selects the first secondary key record that matches the value that you enter. If there is no match, the system selects the next secondary key record in sequence to the value that you enter.
- Press the **Down Arrow** key to select the next secondary key record.
- Press **F4** to return to the maintenance mode selector.
- Press **F5** to select another sort.

Using Sorts in Maintenance Modes

Add

The add mode cannot be used with a secondary sort active. If you try to add a record, the system switches to the change mode.

Change

The change mode displays the secondary key record selection prompt to allow you to select a record. It then allows you to change or maintain the data fields in the record. You cannot change the primary key fields.

Delete

The delete mode alternately displays the secondary key record selection prompt to allow you to select a record. You must then approve each deletion.

F7 Special Functions

When you press **F7 Special Functions**, the system displays the following pop-up menu:

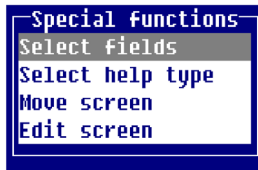

Select fields

This function controls input to fields during maintenance. It allows you to select only those fields you must maintain now. You do not have to move the cursor through each field. The other information can be added at a different time, by a different operator, at a different terminal.

For example, if you have a simple Customer File Screen. When adding a customer, you may only need to add a Customer Code, Name, Address, and Telephone Number immediately. You (or another operator) can enter credit information and outstanding balance at another time. Select the Customer Code, Name, Address, and Telephone Number fields to allow you to move quickly through each new record.

When you select this option, the system places an asterisk (*) into every field. You can maintain only those fields containing an asterisk. Remove the asterisk to restrict access to a field.

NOTE: You cannot remove the asterisk from key or mandatory input fields.

You must select the key fields and required fields as specified in the Format Definition. You may select any number of non-key fields. For more information, see Format Definition in the Dictionary-IV Developer Guide.

Press **F4** to exit this selection. The asterisks are no longer visible.

Select help type

Selects the type of help to display when you press **F6**. When you select this option the system displays the following pop-up menu:

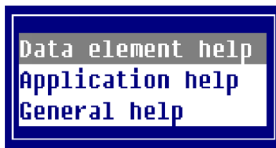

Data element help

Displays on-line help for the fields.

Application help

Displays on-line help for the screen. If no help exists for the screen, general help displays.

General help

Displays on-line help that describes the screens function.

Move screen

Moves the screen. When you select this option, the system displays a **Left/Right Arrow** in the bottom-right corner of the screen. Use the keys in the following chart to move the screen:

<u>Key</u>	<u>Description</u>
Left Arrow	Moves to the left 1 column.
Right Arrow	Moves to the right 1 column.
Back Tab	Moves to the left 5 columns.
Tab	Moves to the right 5 columns.
Up Arrow	Moves up 1 row.
Down Arrow	Moves down 1 row.
Page Up	Moves up 5 rows.
Page Down	Moves down 5 rows.
Enter	Toggle window resize modes.
Home	Expand to maximum number of rows.
. (Period)	Expand to maximum number of rows.
F1	Toggle window resize and window move.
F4	Terminate window resize and window move.

Edit screen

Provides access to all the Screen Editor functions. For more information, see Screen Editor in the Dictionary-IV Developer Guide.

CONNECT VIEW

CONNECT VIEW allows you to view many records at one time. With the appropriate flags set in the view definition header, you may perform maintenance using this view. If there is no data file, the system prompts for creation of the data file.

For more information on view maintenance and views see the Database Maintenance section earlier in this manual. For more information on editing, copying, deleting, and renaming view definitions see Object Views in the Dictionary-IV Developer Guide.

Below you will see a view description:

View Description

0001	Warren Baseball Club	1500 Boulevard Rd	Warren	CT	10075	203 774-2415	003	6	1000	T	1618.55
0002	Lakewood Little League	40 North Main Street	South Hampton	NY	10112	516 384-0221	001	C	1300	T	322.50
0003	Southside Raiders	100 Locust Ave	Rochelle Park	NJ	07011	201 345-3240	004	3	1300	T	412.78
0004	Blue Diamond Baseball	91 Bayway Ave	Brooklyn	NY	10114	718 230-2424	002	6	1300	T	1105.52
0005	Team Sports	503 Genview Dr	New York	NY	10012	212 423-4555	001	9	1300	T	364.05
0006	Westfield Recreation	100 East Broad St	Westfield	NJ	07093	908 232-1500	004	3	1300	T	529.97
0007	Dayton Little Devils Baseball	725 Austin St	Springfield	NJ	07082	908 433-4300	001	C	1300	T	503.70
0008	Hartford Recreation Union	100 Route 66	Hartford	CT	10081	203 340-3434	003	6	1300	T	1388.25
0009	Paramus Little League	750 Walsh Lane	Paramus	NJ	07231	201 238-4001	003	6	1300	T	291.30
0010	Fords Little League All-Stars	1367 North Clark St	Fords	NJ	07034	908 345-8232	002	3	1300	T	347.55
0011	Princeton Amateur League	440 Nassau St	Princeton	NJ	08713	609 353-9080	004	9	1300	T	367.85
0012	Hartensack Hackers	191 Lincoln Drive	Hartensack	NJ	07071	201 452-3544	001	C	1300	T	325.21

<u>Cust Code</u>	<u>Cust Name</u>	<u>Cust Telephone</u>	<u>Open AR Balance</u>
0001	Warren Baseball Club	203 555-2415	
0002	Lakewood Little League	516 555-0221	822.50
0003	Southside Raiders	201 555-3240	412.78
0004	Blue Diamond Baseball	718 555-2424	1105.52

You may select any of the data names defined in the Format Definition to create a view, and there may be many Views for a specific database.

This section describes how to:

- Move through the view while in cursor mode
- Change data in the edit mode
- Modify the view in cursor mode
- Use the **F8** Commands
- CONNECT VIEW Quick Reference

UTCUST in CONNECT VIEW



Code	Customer Name	Rep	YTD Sales
0001	Warren Baseball Club	003	1618.55
0002	Lakewood Little League	001	2388.50
0003	Southside Raiders	004	1153.65
0004	Blue Diamond Baseball	002	1980.50
0005	Team Sports	001	2831.65
0006	Westfield Recreation	004	2785.80

Below you will find a list of functions to assist in using CONNECT VIEW.

CONNECT VIEW

Character-Insert

Character-Delete

F1- Resize/move view

F2-Reverse Sort

F3-Column Width

F5-(Controlled by flag in View Edit.)

F6-Select Data element help.

F7-Carriage Return

F8-Commands

New in CONNECT VIEW

The following are new to CONNECT VIEW:

- **F2**-Reverse Sort reverses the sort order of any data element within a view.
- **Right/Left Arrow** keys wrap at the border. Use the **Tab** and **Back Tab** keys to scroll the window horizontally.
- Delete heading lines by pressing **Line Delete**.
- Press **F16** for a hard copy.
- Column widths can be made larger than the length defined in Format Definition. This allows headings for small fields to be more readable.
- Recover columns to the left or right of the current cursor position.
- **F8**-PRINT command outputs to the printer you define.
- **F8**-SUM command totals numeric columns you define.
- Create columns in a view using a different link.

Selecting CONNECT VIEW

You can execute CONNECT VIEW by selecting **V View (CONNECT VIEW)** from the Dictionary-IV Development Menu or by pressing **F2** from any Dictionary-IV menu and selecting **View**, the system displays the following:

```
Enter a previously defined VIEW, LINK, or FORMAT Name.  
F2 VIEW name lookup  F4 End  F9 Switch to SCREEN Maintenance  
Note: VIEW name lookup will position by entered characters.
```

You can also execute CONNECT VIEW from a pop-up menu by pressing **F1** and adding the CONNECT VIEW to the pop-up menu.

The system displays a window similar to the following:

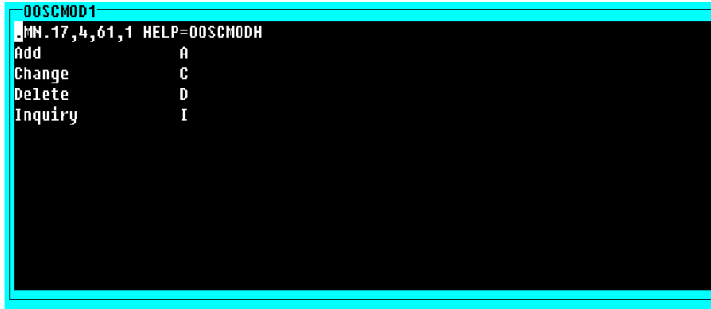

```
00SCMOD1
MNI.17,4,61,1 HELP=00SCMODH
Add          A
Change       C
Delete       D
Inquiry      I
```

For information on executing CONNECT VIEW from a script, see the Script-IV Language Reference.

Performing CONNECT VIEW

When you initiate CONNECT VIEW by entering a VIEW name the system displays the selected View.

Quick Key Reference (Field Edit Mode)

<u>Key</u>	<u>Description</u>
Enter	Switches to the edit field mode for the column selected. From the edit field mode, it also exits to the cursor mode.
Right/Left Arrow	Moves lightbar one field right and left. It wraps on border. (See Tab/Back Tab for horizontal scrolling.)
Down/Up Arrow	Moves lightbar down and up one row. It scrolls at the border.
Character Delete	Removes one character at a time.
Character Insert	Inserts one character at a time without over-typing.
Line Delete/Insert	Deletes records from or adds records to a file.
Tab/Back Tab	Moves lightbar one field right and left. It scrolls the view on the border.
Home	Positions the lightbar at the first or last row of a view or the top row of a view.

<u>Key</u>	<u>Description</u>
Page Down/Up	Moves the lightbar down and up. It goes to next/previous page.
F2	From any data element that has a sort, pressing F2 in a view will reverse the order of the sort.
F3	Prints the window.
F4	Exits the view.
F6	Displays on-line help.
F8	Commands. For more information see F8 Commands.
F9	Switches to screen maintenance.

Maintenance Modes

In CONNECT VIEW there are no maintenance modes. You may add, change, delete, and view records using the normal text editing keys. For more information see Data/Key Change Flags.

Data/Key Change Flags

View Data/Key Change flags determine whether you can use the View to add, change, or delete records. These flags are specified in the View Definition header. The Change Key flag restricts any changes to the key fields. The Change Data flag restricts any changes to the data fields.

The default view sets the flags to restrict changes. You can save the default view, creating a custom view, and then use View Definition to change the file maintenance flags in the definition header. For more information, see Modifying a Default View for Database Maintenance in the Dictionary-IV Developer Guide.

Add

There are two ways to add a record to the file:

- Press the **Line Insert** key. The system inserts a blank line.
- Go to the last record in the file and press the **Down Arrow** key. A blank line appears at the bottom of the file.

Begin typing the new data for the new record. The system saves your entry.

If any mandatory columns have not been entered, you will get the following message:

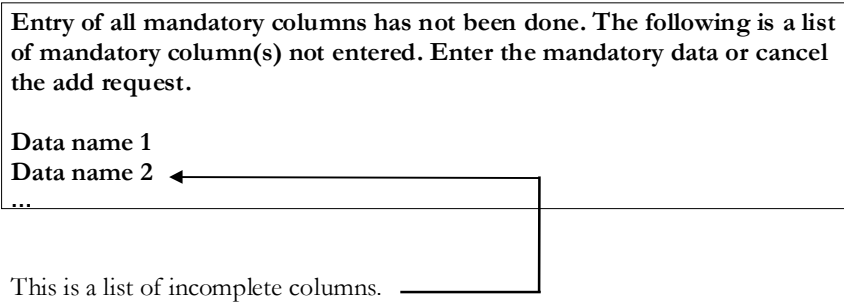

Enter all of the mandatory fields in this list. To cancel the add press **Line Delete**.

Change

There are two ways to change data in a record:

- Position the lightbar on the column and row to be changed and type the data.
- Position the lightbar at the data to be changed, press **Enter**, and type the data.

When a field edit is complete press **Enter** to save the changes and exit the edit mode. If you press **F4** after making changes to a field, the system restores the original data.

Delete

To delete a record from the file:

Position the lightbar on the row to delete and press **Line Delete**. The system highlights the row and prompts:

Delete record?

Select one of the following:

Y Deletes the record.

N Does not delete the record.

If you try to delete a record that does not meet the criteria defined in the Delete Record field in Format definition, the system displays the following message:

To delete selected record, the following condition must be true.

The system displays the condition or conditions. Press **F4** to return to the previous record.

F8 Commands

You may perform the following commands:

<u>Command</u>	<u>Description</u>
COUNT	Counts the rows in the current view.
LIST	Lists the rows in the current view.
PRINT	Outputs the rows in the current view to a printer.
SUM	Sums the numeric columns in the current view.
COPY	Copies rows in the current view to another link.
CHANGE	Changes the rows in the current view.
DELETE	Deletes rows in the current view.
MOVE	Moves a row in the current view to another link.
QUERY	Creates a query that is populated with the information contained in the current view.
EXPORT	Exports the data currently displayed in the View to a .txt file.
EXCEL	Exports the data displayed in the current View to an Excel spreadsheet on the Windows workstation using Thoroughbred's Gateway for Windows.

Each of the **F8** Commands allows you to perform the command using a specific sort sequence, from/to key range, and selection rule.

SORT	select the sort number.
RANGE From	select the first value for the range of the selected sort.
RANGE To	select the last value for the range of the selected sort.
SELECT WHEN	allows you to specify a conditional expression. The expression may contain any valid relational operators. For information see Common Syntax Elements.

You can press **F2** to view or select valid data names from a pop-up menu.

Example:

```
#UTCUST.STATE = "NJ"  
#UTCUST.YTD-SALES > 2000,AND UTCUST.YTD-SALES <3000  
POS("BASEBALL" = CVT (#UTCUST.CUST-NAME, 32))
```

When your specifications are complete press **Enter**. The following commands are listed alphabetically.

CHANGE

Changes the rows in the current view. The data change flag must be set to Y in View edit. The change can be done based on a specific sort sequence, from/to key range and a selection rule.

```

CHANGE...
SORT: 0 RANGE From:
                To:
SELECT WHEN:
-----
CHANGE WHAT:
Verify (Y/N):

```

CHANGE WHAT

Allows you to specify an assignment expression. The expression can only contain the expression = (equal to).

Press **F2** to view or select valid data names from a pop-up menu.

Example:

```
#UTCUST.STATE = "NJ"
```

Verify

Requests verification for each assignment being changed.

Select one of the following:

Y The system requests verification for each record to be changed.

N The system changes the records without verification.

When your specifications are complete press **Enter**.

COPY

Copies data in the current view to another link. The data in the current view is not affected. The copy can be done based on a specific sort sequence, from/to key range, and a selection rule.

```

COPY...
SORT: 0 RANGE From:
                To:
SELECT WHEN:
-----
Link name:      [(Y/N) Verify:  Replace:  Ask before replace: ]

```

Link name

Type the link name to which the data is to be copied and press **Enter**.

Verify

Requests verification before each record to be copied. Select one of the following:

Y The system requests verification for each record to be copied. The system will prompt: Copy record?
Y copies the record; **N** does not copy the record.

N The system copies the records without verification.

Replace

Replaces records in the destination link. Select one of the following:

Y Overwrites the record when the key is the same.

N Does not copy the record if the record exists in the destination link. Automatically places an N in the Ask before replace field.

Ask before replace

When you select **Y** in the Replace field you must select one of the following:

Y The system requests verification before replacing a record.

N The system does not request verification before replacing a record.

When your specifications are complete press **Enter**.

COUNT

Counts the rows in the current view. The count can be done based on a specific sort sequence, from/to key range, and a selection rule.

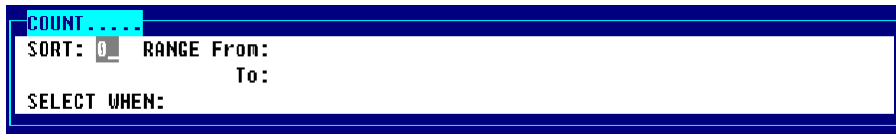

```
COUNT...
SORT: 0 RANGE From:
                To:
SELECT WHEN:
```

DELETE

Deletes rows in the current view. The delete can be done based on a specific sort sequence, from/to key range, and a selection rule.

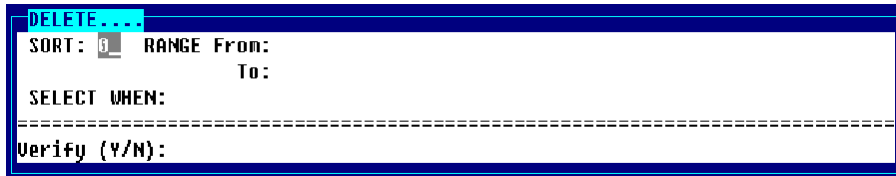

```
DELETE...
SORT: 0 RANGE From:
                To:
SELECT WHEN:
-----
Verify (Y/N):
```

The delete values must conform to the rules defined in Formats. See the Formats section in Dictionary-IV Developer Guide.

Verify

Requests verification for each record to be deleted. Select one of the following:

Y The system requests verification for each record to be deleted.

N The system deletes the records without verification.

When your specifications are complete press **Enter**.

If you try to delete a record that does not meet the criteria defined in the Delete Record field in Format definition, the system displays the following message:

To delete selected record, the following condition must be true.

The system displays the condition or conditions.

Press **F4** to type another value.

EXCEL

This option exports the data displayed in the current View to an Excel spreadsheet on the Windows workstation using Thoroughbred's Gateway for Windows product. The data to be exported can be refined by specifying a SORT, RANGE From/To, and a SELECT WHEN clause.

A new Excel workbook is created each time Excel is selected for output. To change workbooks, select the appropriate Microsoft Excel Book in the task bar, or from the Excel menubar select Window and then select the appropriate Book (window).

EXPORT

This option exports the data currently displayed in the current View to a .txt file. The file is created in the default data file directory defined by #IDSV.DISK.NBRDATAFILES.

LIST

Lists the rows in the current view. The list can be done based on a specific sort sequence, from/to key range, a selection rules, and text field search rules. The list will be displayed in the view window.

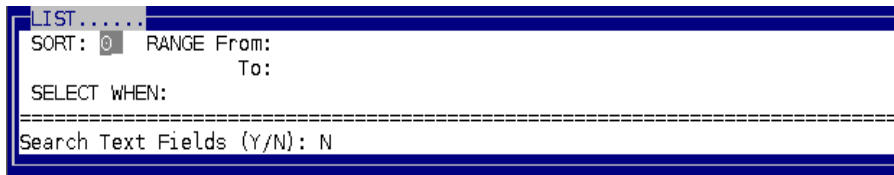

For more information on the LIST function, please see the OPENworkshop reference manual or on- line help.

MOVE

Moves rows in the current view. The move can be done based on specific sort sequence, from/to key range and a selection rule. Removes the record from the current view. The system prompts for creating a data file, if this has not been done.

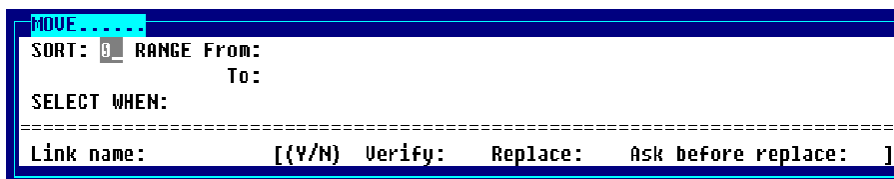

If you try to move a record that does not meet the criteria defined in the Delete Record field in Format definition, the system displays the following message:

To delete selected record, the following condition must be true.

The system displays the condition or conditions.

Link name

Allows you to enter the link name to which the data is being moved.

Verify

Requests verification for each record to be copied. Select one of the following:

Y The system requests verification for each record to be moved.

N The system moves the records without verification.

Replace

Allows you to replace records in the destination link. Select one of the following:

Y Moves the record and replaces records in the destination link.

N Does not move the record if the record exists in the destination link. Automatically places an N in the Ask replace field.

Ask before replace

When you select **Y** in the Replace field you must select one of the following:

Y The system requests verification before replacing a record.

N The system does not request verification before replacing a record.

When your specifications are complete press **Enter**.

PRINT

Outputs rows in the current view to a defined printer. The print can be done based on a specific sort sequence, from/to key range, and a selection rule.



A screenshot of a terminal window showing the **PRINT** command prompt. The prompt is highlighted in blue. Below the prompt, there are three lines of text: "SORT: 0 RANGE From:", "To:", and "SELECT WHEN:". The "0" in "SORT: 0" is highlighted in blue.

The system prompts:

Select printer (LP, P1, Pn):

QUERY

Opens Query-IV Framer and creates a query that is populated with the information contained in the current view.

SUM

Summarizes numeric columns in the current view. The sum can be done based on a specific sort sequence, from/to key range, and a selection rule.



A screenshot of a terminal window showing the **SUM** command prompt. The prompt is highlighted in blue. Below the prompt, there are three lines of text: "SORT: 0 RANGE From:", "To:", and "SELECT WHEN:". The "0" in "SORT: 0" is highlighted in blue.

The system displays a listing of all numeric data elements that fit the criteria.

#UTCUST	
Credit Limit	6 Num
Open AR Balance	10 Num
YTD Sales	10 Num

Press **Enter** to select or deselect a data name. The system adds or removes the data name from the list.

```

CREDIT-LIMIT
OPEN-AR-BALANCE
YTD-SALES
  
```

When your selections are complete press **F4** and the system displays the view beginning at the upper left corner.

SUM.....		Demo Customer File	
Code	Customer Name	Rep	YTD Sales
			22868.95

Customer Code

Scroll to the data name you summed.

SUM.....		Demo Customer File	
Code	Customer Name	Rep	YTD Sales
			22868.95

YTD Sales

Press **Enter** to view an arithmetic summary of the data in this data element.
The system displays a screen similar to the following:

Field Name:YTD-SALES	
Record count :	13.00
Field total :	22,868.95
Minimum value :	.00
Maximum value :	2,831.65
Average value :	1,759.15
Non-Zero count :	12.00
Non-Zero Average :	1,905.75

Record count

Displays the total number of records matching the range and selection specifications.

Field total

Displays the sum of all the records matching the range and selection specifications.

Minimum value

Displays the minimum value in the records matching the range selection specifications.

Maximum value

Displays the maximum value in the records matching the range selection specifications.

Average value

Displays the average value in the records matching the range selection specifications.

Non-Zero count

Displays the number of non-zero records matching the range selection specifications.

Non-Zero average

Displays the average of the non-zero records matching the range selection specifications.

Changing the Appearance of a View

You can change the appearance of a default or custom view and save it for future use. The following keys alter the appearance of a view.

Quick Key Reference

<u>Key</u>	<u>Description</u>
F1	Resize/Move window. For more information see Resize/Move Window.
F4	End.
F6	Help.
F7	Special functions.
F8	Commands.
F9	Single record maintenance.
F10	Goto a specified row or column.
F11	Field definition.
F16	Print copy.
Enter	Switches to the edit field mode for the column selected. From the edit field mode, it also exits to the cursor mode.
Right/Left Arrow	Moves lightbar one field right and left. It wraps on border. (See Tab/Back Tab for horizontal scrolling.)
Down/Up Arrow	Moves lightbar down and up one row. It scrolls at the border.
Character Delete	Removes the current column from the view.
Character Insert	Recovers a column at the current position.
Line Delete/Insert	Deletes rows from or inserts rows into a view. Deletes/adds records.
Tab/Back Tab	Moves lightbar one field right and left. It scrolls the view on the border.
Home	Positions the lightbar at the first or last row of a view or the top row of a view.
Page Down/Up	Moves the lightbar down and up. It goes to next/previous page.

To insert a column at the end of a view, position the lightbar at the last column. Press **Character-Insert**, select the column to restore, and press the **Right Arrow** key instead of **Enter**. You may also select a column from a different link. For more information see Char-Insert Using a Different link.

Cursor Movement in Cursor Mode (Through the View)

When you first access the View you are in cursor mode. In cursor mode you can move through the View or modify the View.

NOTE: To edit any particular field position the cursor at the record and column. Press **Enter** and you are in the field edit mode. Make the changes and press **Enter** again to exit the field edit mode and return to the cursor mode. When you are in the field edit mode, you may use the normal text editing keys.

This section describes keyboard functions in the cursor mode. You may scroll through the View using the following keys:

Page Up/Down

Moves up/down one view length.

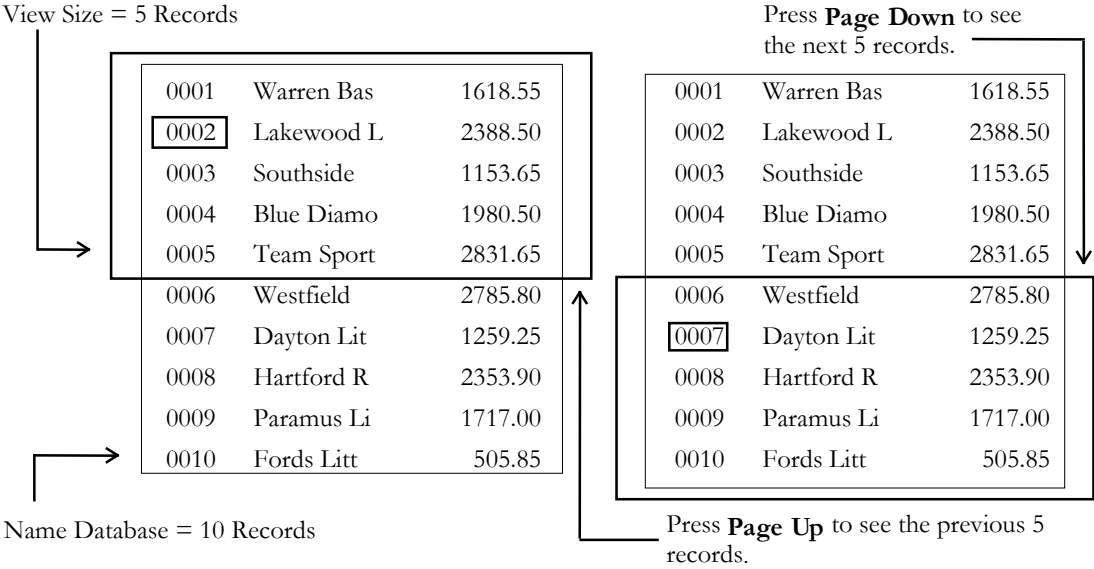

Up/Down Arrow

Moves up/down one record within the field.

Press **Down Arrow** to select the next record.

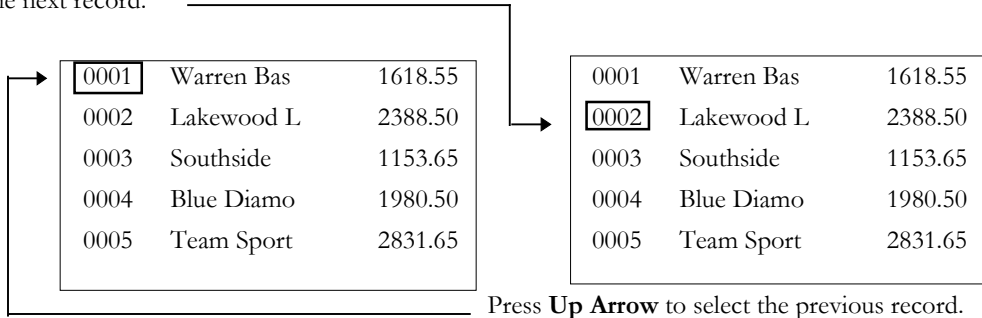

Press **Up Arrow** to select the previous record.

0001	Warren Bas	1618.55
0002	Lakewood L	2388.50
0003	Southside	1153.65
0004	Blue Diamo	1980.50
0005	Team Sport	2831.65

Press **Down Arrow** at the bottom of the view.

The lightbar scrolls down according to the following formula:

$$\text{Number-of-lines-in-view} / 2$$

Press **Up Arrow** at the top of the view. The lightbar scrolls up according to the above formula.

0004	Blue Diamo	1980.50
0005	Team Sport	2831.65
0006	Westfield	2785.80
0007	Dayton Lit	1259.25
0008	Fords Litt	505.85

Left/Right Arrow

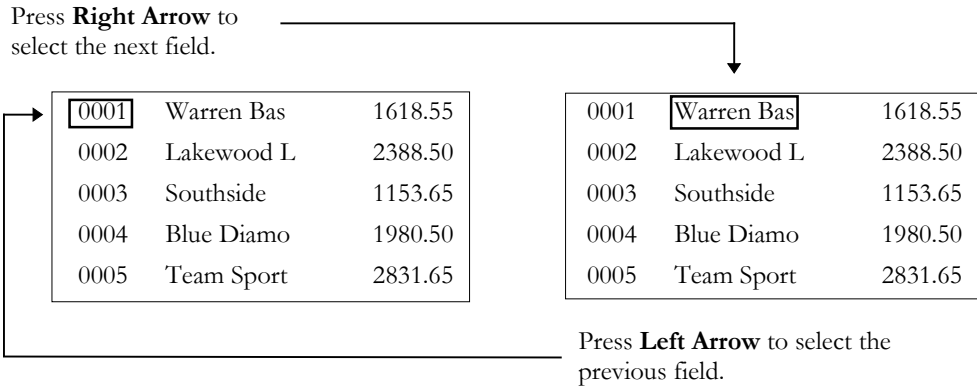

Moves left/right one field within the window. It does not scroll outside the window.

Tab/Back Tab

Moves one field to the right/left. If it reaches the right most field in window, the tab scrolls to the next field outside the window.

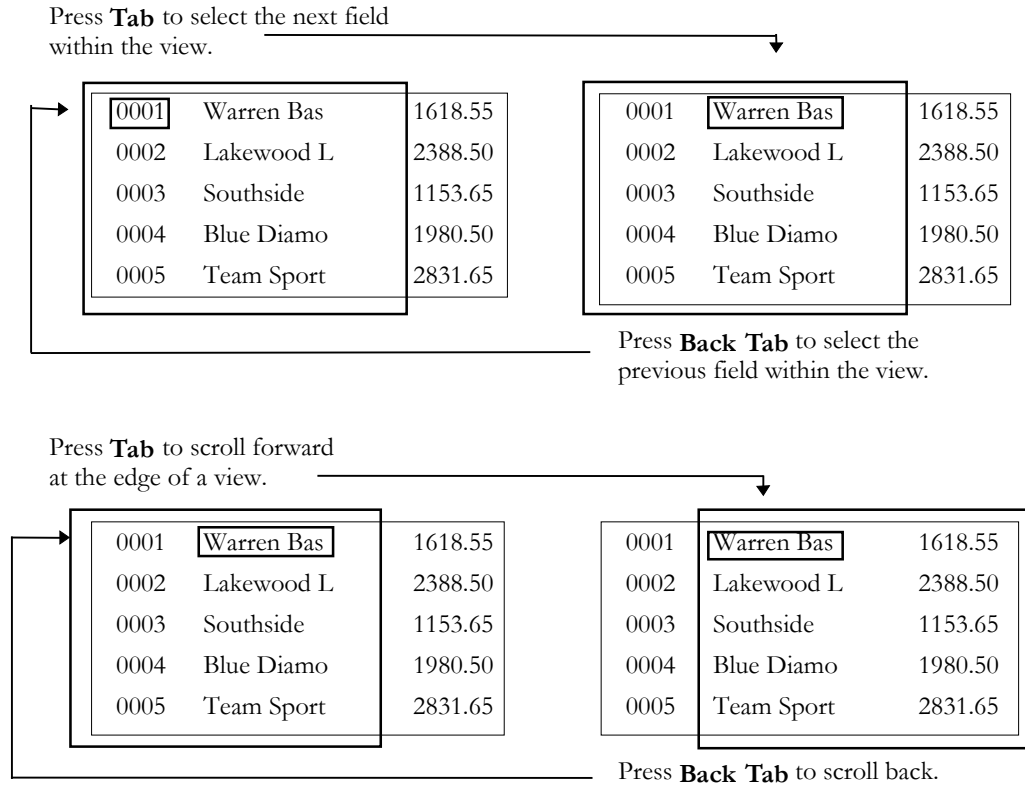

Home

The action of the **Home** key depends on where it is currently positioned.

Moves first to the leftmost position of the current window. Moves to the leftmost field of the current record. Moves to the first field of the first record in the window. Moves to the first field of the first record in the file. Moves to the first field of the last record in the file. Moves to the first field in the current window.

0001	Warren Bas	1618.55
0002	Lakewood L	2388.50
0003	Southside	1153.65
0004	Blue Diamo	1980.50
0005	Team Sport	2831.65
0006	Westfield	2785.80
0007	Dayton Lit	1259.25
0008	Hartford R	2353.90
0009	Paramus Li	1717.00
0010	Fords Litt	505.85

← Initial position

Press the **Home** key to move to the left-most field of the current window.

0001	Warren Bas	1618.55
0002	Lakewood L	2388.50
0003	Southside	1153.65
0004	Blue Diamo	1980.50
0005	Team Sport	2831.65
0006	Westfield	2785.80
0007	Dayton Lit	1259.25
0008	Hartford R	2353.90
0009	Paramus Li	1717.00
0010	Fords Litt	505.85

Press the **Home** key to move to the left-most field of the current record.

0001	Warren Bas	1618.55
0002	Lakewood L	2388.50
0003	Southside	1153.65
0004	Blue Diamo	1980.50
0005	Team Sport	2831.65
0006	Westfield	2785.80
0007	Dayton Lit	1259.25
0008	Hartford R	2353.90
0009	Paramus Li	1717.00
0010	Fords Litt	505.85

Press the **Home** key to move to the first field of the first record in the window.

0001	Warren Bas	1618.55
0002	Lakewood L	2388.50
0003	Southside	1153.65
0004	Blue Diamo	1980.50
0005	Team Sport	2831.65
0006	Westfield	2785.80
0007	Dayton Lit	1259.25
0008	Hartford R	2353.90
0009	Paramus Li	1717.00
0010	Fords Litt	505.85

Press the **Home** key to move to the last record in the file.

0001	Warren Bas	1618.55
0002	Lakewood L	2388.50
0003	Southside	1153.65
0004	Blue Diamo	1980.50
0005	Team Sport	2831.65
0006	Westfield	2785.80
0007	Dayton Lit	1259.25
0008	Hartford R	2353.90
0009	Paramus Li	1717.00
0010	Fords Litt	505.85

The **Home** key now toggles between the first field of the first and last records in the file.

Enter

Selects the field edit mode. For more information see Software Conventions (Field Edit).

F1 Resize/move view

Moves or resizes the window.

The system displays the resize box in the lower left corner. Press **Enter** to move between resize modes. Press **F1** to toggle between resizing and moving the window.

Resize Window

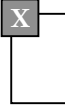
Key \ Mode	 Bottom row and right column move to expand and reduce the window size.	 Top row and left column move to expand and reduce the window size.
Left Arrow Right Arrow Back Tab Tab Up Arrow Down Arrow Page Up Page Down	decreases width 1 column increases width 1 column decreases width 5 columns increases width 5 columns decreases height 1 row increases height 1 row decreases height 5 rows increases height 5 rows	increases width 1 column decreases width 1 column increases width 5 columns decreases width 5 columns increases height 1 row decreases height 1 row increases height 5 rows decreases height 5 rows
Enter Home . (Period) F1 F4 F7	toggle window resize modes. expand to maximum number of rows. expand to maximum number of columns. toggle window resize and window move. terminate window resize and window move. special functions menu.	

Press **F7** to select the following options:

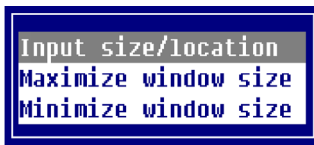

Input size/location

Allows the size of a text window to be changed. The window text size values will be displayed in an input window.

```
78,14,0,7
```

Window Size: 78 columns, 11 rows.
Coordinates: column 0, row 10.

The above window size values are columns and rows of text excluding borders.

Maximize window size

Expands the window size to the maximum size allowed. The window location will not be changed. The window will be expanded from the top down and from right to left

Minimize window size

Reduces the window size to the minimum size allowed. The window will be reduced from the bottom up and from right to left.

Press **F1** to enter the move mode.

Move Window

<u>Key</u>	<u>Description</u>
Left Arrow	Moves to the left 1 column.
Right Arrow	Moves to the right 1 column.
Back Tab	Moves to the left 5 columns.
Tab	Moves to the right 5 columns.
Up Arrow	Moves up 1 row.
Down Arrow	Moves down 1 row.
Page Up	Moves up 5 rows.
Page Down	Moves down 5 rows.
Enter	Toggle window resize modes.
Home	Expand to maximum number of rows.
. (Period)	Expand to maximum number of rows.
F1	Toggle window resize and window move.
F4	Terminate window resize and window move.

F6 On-line Help

Displays on-line help. When you press **F6** the system displays the following pop-up menu:

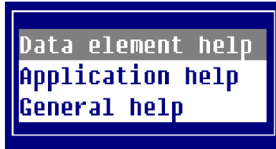

Data element help

This displays on-line help for the current column.

Application help

This contains a help module, which provides overall help for the view. Usually this help gives the user an idea as to the need for a view rather than detail information about individual items in the view.

General help

This displays on-line help that describes how to use the view. The following help displays.

General On-line Help

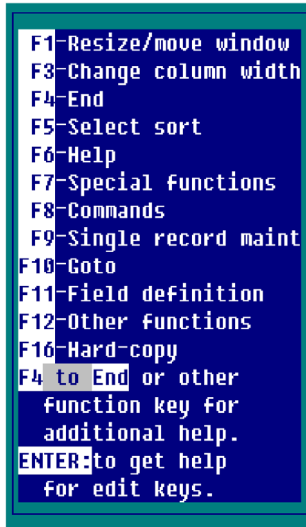

Press a function key or **Enter** for detailed information. Press **F4** to exit.

Character-Insert Using a Different Link

You may add columns to the view using a Link to another Format. When you press **Character-Insert** the system displays a window similar to the following:



The A<?> (B<?>,C<?>, etc.) option allows you to define a column from a different Link. By default, the system creates the column to the left of the position of the lightbar.

Press the **Right Arrow** key to create the column to the right of the lightbar.

Select A<?>. The system displays the following:

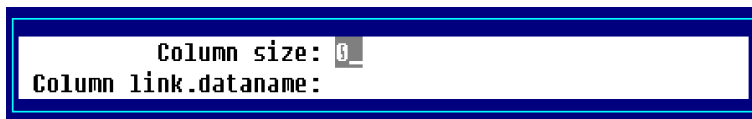

Enter the following information:

Column size

Type the length of this new column and press **Enter**.

Column link.dataname

Type the 3 to 8 character Link name and data name for the field to display in this view. The Link must define a keyed data file. The data name must be contained in the Format specified in the Link.

Example:

In a view that uses the Link UTCUST, **UTREP.REP-NAME** would select the data element REP-NAME from the UTREP Format. The system would place the sales rep names in the view. This works because the field REP-CODE exists in UTCUST. The same data name is the key in UTREP, therefore linkage is possible.

F7 Special Functions

Select **F7 Special functions** and the system displays the following:

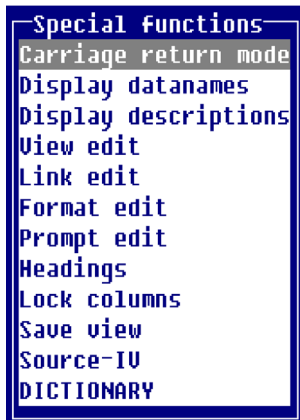

Carriage return mode

Controls the direction the lightbar will move after field editing. Valid directions are right, left, up, and down.



Display datanames

Turns the data name display feature on and off. When on, the following information about the current column appears at the bottom of the view:

- Data name.
- Maximum entry length of the field.
- Current width of the column.
- Carriage return direction mode (Enter key).

Display Data Names

Demo Customer File				
Code	Customer Name	Rep	YTD Sales	
0001	Warren Baseball Club	003	1618.55	
0002	Lakewood Little League	001	2388.50	
0003	Southside Raiders	004	1153.65	
0004	Blue Diamond Baseball	002	1980.50	
0005	Team Sports	001	2831.65	
0006	Westfield Recreation	004	2785.80	

CUST-CODE(4) (4) <CR>=D

CUST-CODE	Data Name
(4)	Current column width
(8)	Maximum field entry length
<CR>=D	Carriage return mode

Display descriptions

Turns the description display feature on and off. When on, the following information about the current column appears at the bottom of the view.

Data description (defined in format).

Display Data Descriptions

Demo Customer File				
Code	Customer Name	Rep	YTD Sales	
0001	Warren Baseball Club	003	1618.55	
0002	Lakewood Little League	001	2388.50	
0003	Southside Raiders	004	1153.65	
0004	Blue Diamond Baseball	002	1980.50	
0005	Team Sports	001	2831.65	
0006	Westfield Recreation	004	2785.80	

Customer Code

Customer Code Data description.

View edit

Allows modifications to the view specifications. Each specification that can be modified will have help available (**F6**). If access is denied to this function, see your system administrator for additional explanation.

View Edit

Name: UTCUST Desc: Demo Customer File	
--Yes/No Flags--	-----Indicators-----
Key changes.....: Y	Border heading.: D (D,U,B,N)
Data changes.....: Y	CR action.....: F (F,S,s,E)
Display headings: Y	Cursor type.....: E (C,E,F)
View alterations: Y	DN/Desc display: d (N,D,d)
Sort seq changes: Y	CR direction....: D (U,D,L,R)
Print zero's.....: Y	
Help:	Sort menu:

Key changes

Controls the ability to add, delete, and modify records and to use **F8** CHANGE, DELETE, COPY, and MOVE commands in a view. Select one of the following:

Y Allows changes to the key fields in the view.

N Does not allow you to change the key fields.

Data changes

Controls the ability to add, delete, and modify records and to use **F8** CHANGE, DELETE, COPY, and MOVE commands in a view. Select one of the following:

Y Allows changes to the non-key fields in the view.

N Does not allow you to change the non-key fields.

Display headings

Turns on or off the view headings. Select one of the following:

Y Displays the heading lines.

N Does not display the heading lines.

View alterations

Controls the ability to delete or insert columns or to save a view. Select one of the following:

Y Allows view specification changes.

N Does not allow view specification changes.

Sort seq changes

Turn on or off the ability to use **F5** Sort to select a different sort sequence. Select one of the following:

Y Allows view sort changes.

N Does not allow view sort changes.

Print zeros

Display/print zeros or blanks for the numeric value zero. Select one of the following:

Y Prints zeros (0) when the numeric data is zero (0).

N Prints blanks when the numeric data is zero (0).

Border heading

Contains view window heading specifications. The headings always display in the top border of the view window. Select one of the following:

- D** The view description is centered in the top border.
- V** The eight-character view name is displayed in the left-most top border.
- B** Both the eight-character view name and description are displayed in the top border.
- N** No headings display in the top border.

CR Action

Defines the action of the **Enter** key while in the view. Select one of the following:

- F** Enter the normal field edit mode.
- S** Enter screen maintenance.
- s** Enter screen maintenance and return to View after record is edited.
- E** Exit the view.

Cursor type

Defines the view lightbar specifications. Select one of the following:

- C** One character cursor marks the column/row intersection.
- E** Full field lightbar marks the column/row intersection.
- F** The full row is marked with the lightbar.

DN/Desc display

Displays the data names in the bottom border of the view flag. Select one of the following:

- N** Do not display the data name or description.
- D** Display the data name.
- d** Display the data name description.

CR direction

Defines the direction of the lightbar movement after pressing the **Enter** key to modify a field. Select one of the following:

- U** The lightbar goes up to the prior row.
- D** The lightbar goes down to the next row.
- L** The lightbar goes left to the previous column.
- R** The lightbar goes right to the next column.

Help

Contains the name of the help module, which provides the text, to use for the view under the application help option.

Sort Menu

Contains the name of a menu to be used in place of the default selection pop-up menu. This menu can be more application specific than the default sort selection menu.

Example:

In a customer file you may decide to restrict usage of a sort on sales. You may create a custom sort menu that does not include this sales sort.

When defining a sort menu, you must return a valid sort number with each selection contained in the developer-supplied menu. For example:

.MN.13,4,65,1	
Customer Name	1
Salesrep	2
State	3
Zip Code	4

It also allows you to present the data in a more readable display.

View Method

Contains the name of a developer supplied method that will be called each time a view row is to be displayed. The method will build all new column values that have been defined by new columns A<x> through Z<x>. The view method is specified in the view header.

Link edit

Displays the Link Definition for this View. You may edit this definition and sorts. For more information see Link Definition in the Dictionary-IV Developer Guide.

If the system denies you access to this function see your system administrator for assistance.

Format edit

Displays the Format Definition for this View. You may edit this definition. For more information see Format Definition in the Dictionary-IV Developer Guide.

If the system denies you access to this function see your system administrator for assistance.

Prompt edit

Modifies the help text containing view/screen prompts that were referenced by VP[n] or SP[n]. For more information, see Format Definition in the Dictionary-IV Developer Guide.

Headings

Activates the heading edit mode. If headings have not been defined for a view, one blank line will be inserted and the entire view is shifted down. Once in heading edit mode, the **Arrow** and **Tab** keys can be used to select the desired column. You may type the desired heading values. Use the **Line Insert** key to add as many heading lines as desired.

To remove a heading line press **Line Delete**. Press **F4** to exit heading mode.

You may make the column width larger than the field length defined in the format. This does not allow you to change the length of the data entered in the column, but it does allow you to increase the width of the heading.

For example: If you have a 2-character State column, you may press **F7**, select Column width, and increase the size to 5. This still only allows 2-character data entry, but allows you a 5-character heading. You may now type the heading **State**.

Lock columns

Locks and unlocks columns to the left of and including the column on which the lightbar is located. These columns remain stationary when scrolling in the view.

Lock Columns

Vertical line designates a locked column.



Code	Customer Name	Rep	YTD Sales
0001	Warren Baseball Club	003	1618.55
0002	Lakewood Little League	001	2388.50
0003	Southside Raiders	004	1153.65
0004	Blue Diamond Baseball	002	1980.50
0005	Team Sports	001	2831.65
0006	Westfield Recreation	004	2785.80

If two columns were locked, the vertical line would be placed to the right of the Customer Name column. These two columns then remain stationary when scrolling in the view.

Save view

Saves the view. The save process preserves all view attributes including deleted and locked columns, reduced field sizes, sort pattern, and any view size. There is no prompt for a view name or confirmation of changes.

Source-IV

Displays the *Source-IV* menu and allows you to make selections. This function is only available if the environment is defined as an OPENworkshop Development environment.

For more information see the *Source-IV* and *OPENworkshop* reference manuals.

DICTIONARY

Displays the following menu:



This function is only available if the environment is defined as an OPENworkshop development environment.

For more information about the Class Definitions see the Dictionary-IV Developer Guide. For more information see the OPENworkshop Reference Manual.

F10 Goto

Positions to a column or row specified by an operator-entered key. The system prompts:

F1-Left, F2-Right, F10-Goto Column

To go to a specific row, type the key value (for the selected sort). The system begins the view with the closest match to the value you typed. To go to a specific column, you can use the following function keys:

- F1** Moves to the right-most column.
- F2** Moves to the left-most column.
- F10** Displays a lookup of columns. You may select the column to move to.

F11 Field Definition

Allows the display of data name attributes for the column on which the cursor is located.

The following function keys are active:

F3 Displays the following menu:

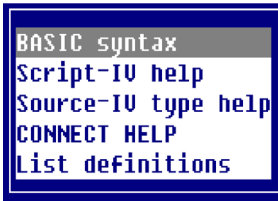

You can display help for Basic, Script-IV, Source-IV, and CONNECT. It also allows you to list the definitions class (Formats, Screens, Views, Links, Menus, Messages, Help, Windowed Help, Scripts, Reports, and Queries).

F7 Displays the following menu:

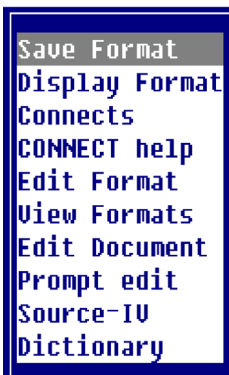

F10 Displays the Command Line Entry Window.

You can press **F10** to display the Command Line Entry Window. From this window you can perform Dictionary-IV maintenance, CONNECT to Utility Methods, and CONNECT to Developer Methods. Access to the **F10** command line can be blocked by disabling this feature in the Installation Information screen. For more information see the OPENworkshop Reference Manual.

Save Format

Saves modifications made to the data element attributes.

Display Format

Displays the entire Format.

Connects

Displays data names that have CONNECT directives.

CONNECT help

Connects to a Help menu that provides detail help for using the CONNECT directive.

Edit Format

Allows you to edit the current Format.

View Formats

Displays a View of Formats.

Edit Document

Allows you to edit the text document.

Source-IV

Connects to the Source-IV Main Menu.

Dictionary

Connects to the Dictionary-IV Main Menu.

F11 Displays the Data name and attributes. Position the cursor at the column you wish to view and press **F11**. The system displays the following (for more information see Format Definition in the Dictionary-IV Developer Guide):

Fld Num	Displays the number of the field.
Data Name	Displays the Data name.
Size	Displays the length of the field.
FS	Displays Y if field separators are used; displays N if field separators are not used.
Help Code	Displays the name of the help file.
KY	Displays Y if this field is a key; displays N if this field is not a key.
ET	Displays the entry type (optional, fixed length/optional, variable length/required, fixed length/required, variable length).
NT	Displays the numeric type.
PD	Displays the padding type.
DT	Displays the date formatting.
YN	Displays Y if this is a Yes/No field; Displays N if this is not a Yes/No field.

Format
Offset

Press **F11** again to display the following attributes:

- 1 - Valid Values
- 2 - Preset Values
- 3 - Delete Values
- 4 - Security
- 5 - Special Prompt
- 6 - Pre Process
- 7 - Post Process
- 8 - Audits
- 9 - Help General

CONNECT MENU

The CONNECT MENU command enables you to connect to a pop-up menu. This can be done from a script, menu definition, or Dictionary-IV menu.

Example of a Pop-up Menu from a Dictionary-IV Menu

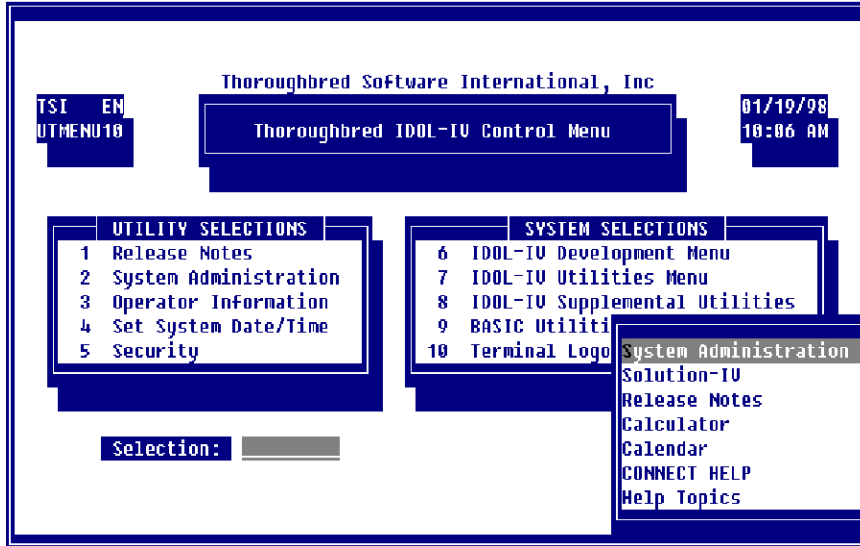

Hot Key (Ctl-P) Pop-Up Menu

For more information about creating a pop-up menu see Help Definition in the Dictionary-IV Developer Guide.

Selecting Options in Pop-up Menus

If a pop-up menu displays you may make your selection in the following ways:

- Type the first letter of the option and press **Enter**. The system highlights the first match.
- Use the **Down Arrow**, **Up Arrow**, **Page Up**, **Page Down**, and **Home** keys to highlight the selection and press **Enter**.

Quick Key Reference

From the Selection field on any Dictionary-IV menu you may type the option number and press **Enter** to retrieve that option. You may also use the following function keys:

<u>Key</u>	<u>Description</u>
F1	Edit menu. For more information see F1 Edit Menu.
F3	Screen print. Press this function key to print the screen. The system prompts for the printer. Type the printer name (LP, P1, etc.) and press Enter .
F4	Exit Pop-up menu.
F7	Change the language code in multi-language applications. For more information see Multi-language in the Dictionary-IV Administrator Guide.
F8	Move menu. For more information see F8 Move Menu.
F9	Expand/Compress menu.
F10	Exit.
F16	Print hard copy of the menu. The system prompts for the printer name (LP, P1,...). Type the printer name and press Enter .

Cursor Movement

You may use the following keys in CONNECT MENU:

<u>Key</u>	<u>Description</u>
Down Arrow	Moves the lightbar down one row.
Up Arrow	Moves the lightbar up one row.
Page Down	Moves the lightbar down one page.
Page Up	Moves the lightbar up one page.
Home	Moves the lightbar to the first option in the window, the first option in the menu, and to the last option in the menu.
Enter/F2	Selects the highlighted menu option.

F1 Edit Menu

Displays the menu with all its parameters. You may edit the menu if you are defined as a developer. For more information see Operator Information in the Dictionary-IV Administrator Guide. Also see Help Definition in the Dictionary-IV Developer Guide.

F8 Move Menu

Moves the menu left, right, up, or down by pressing the appropriate **Arrow** key. Use the **Tab** and **Back Tab** keys to move the menu left and right.

CONNECT HELP

The CONNECT HELP command enables you to connect to a help definition and display, edit, or create help text. This can be done from a script, menu definition, or Dictionary-IV menu.

Selection

The following is an example of CONNECT HELP:

CONNECT HELP

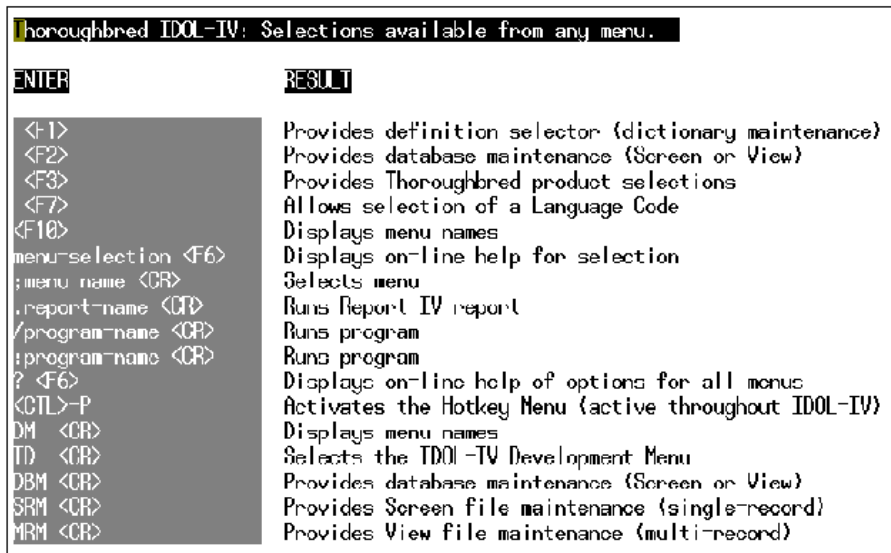

ENTER	RESULT
<F1>	Provides definition selector (dictionary maintenance)
<F2>	Provides database maintenance (Screen or View)
<F3>	Provides Thoroughbred product selections
<F7>	Allows selection of a Language Code
<F10>	Displays menu names
menu-selection <F6>	Displays on-line help for selection
;menu name <CR>	Selects menu
.report-name <CR>	Runs Report IV report
/program-name <CR>	Runs program
:program-name <CR>	Runs program
? <F6>	Displays on-line help of options for all menus
<CTL>-P	Activates the Hotkey Menu (active throughout IDOL-IV)
DM <CR>	Displays menu names
TD <CR>	Selects the IDOL-IV Development Menu
DBM <CR>	Provides database maintenance (Screen or View)
SRM <CR>	Provides Screen file maintenance (single-record)
MRM <CR>	Provides View file maintenance (multi-record)

For more information, see Help Definition in the Dictionary-IV Developer Guide.

Quick Key Reference

<u>Key</u>	<u>Description</u>
F1	Edit help. For more information see F1 Edit Help.
F3	Print screen. Press this function key to print the screen. The system prompts for the printer name (LP, P1, etc.) Type the printer name and press Enter .
F4	End help. For more information see Software Conventions (Function Keys).
F7	Special Functions. For more information see F7 Special Functions in Help Definition in the Dictionary-IV Developer Guide.
F8	Move help. Allows you to move the help text window left, right, up, or down using the arrow keys.
F9	Expand/compress help.
F10	Exit from all help levels and returns to the last screen/menu.
F16	Print hard copy. Prints the help text. The system prompts for the printer name (LP, P1, etc.). Type the printer name and press Enter .

Cursor Movement

<u>Key</u>	<u>Description</u>
Left Arrow	Moves one space to the left.
Right Arrow	Moves one space to the right.
Up Arrow	Moves one-half window up.
Down Arrow	Moves one-half window down.
Page Up	Moves one window up.
Page Down	Moves one window down.

F1 Edit Help

Displays the help and the help module name. You may edit the help text if you are defined as a developer. For more information see Operator Information in the Dictionary-IV Administrator Guide. Also see Help Definition in the Dictionary-IV Developer Guide.

CONNECT REPORT/CONNECT QUERY

CONNECT REPORT enables you to execute a Report-IV report and display or print it.

CONNECT QUERY enables you to execute a Query-IV query and display or print it.

Selection

When you CONNECT REPORT or CONNECT QUERY the system prompts:

Do you want a printed copy?

Select one of the following

N The system displays the report or query on your terminal.

Y The system prompts:

Select printer (LP, P1, P2, ...).

Messages

If you display a report or query on the terminal, you may get the following messages:

CR to continue

There are more rows in the table than will fit on the screen press **Enter** to scroll down.

Enter Window Control

There are more columns in the table than will fit on the screen. Use the following keys to scroll the table to view additional columns.

<u>Key</u>	<u>Description</u>
Left Arrow	Moves one space to the left.
Right Arrow	Moves one space to the right.
Back Space	Moves the window left one column.
Up Arrow	Moves to the center of the table.
Home	Left/Right Side Progressive: jumps to the left and right sides of the table.
Tab	Moves the window five characters right.
Back Tab	Moves one window five characters left.

End of Query

There are no more rows. The last row of the table has been displayed.

F4-END

Press **F4** to end the report or query and return to the place of execution.

TEXT EDITOR

This section documents the text editor used by:

- Windowed help text,
- Pop-up menus, and
- Text fields.

For information about these refer to the appropriate reference manual.

Using the Text Editor

The following is a description of how to use the Text Editor.

Quick Key Reference

<u>Key</u>	<u>Description</u>
F1	Split line. For more information see F1 Split Line.
F2	Join line. For more information see F2 Join Line.
F4	End. Prompts for saving and exiting the help text. For more information see Software Conventions (Function Keys).
F5	Format Text. For more information see Change Tab Line in F7 Special Functions.
F6	Help. Provides a network of help on how to use the editor.
F7	Special Functions. For more information see F7 Special Functions.
F8	Search/Replace. For more information see F8 Search and Replace.
F9	Expand window. Expands the number of window rows to 23 rows. If the window is currently expanded, then it will be reduced to the originally defined number of rows.
F10	Goto. For more information see F10 Goto.
F11	Margin. For more information see F11 Margin.
F12	Copy. Select a document name to copy. For more information see F12 Copy.

<u>Key</u>	<u>Description</u>
F13	Cut/Paste. For more information see F13 Cut and Paste.
F14	Undo. For more information see F14 Undo.
F15	Char/Grph mode. For more information see F15 Character/Graphics Mode - Video Attributes, Graphics and Color.
F16	Print. Allows the contents of the window being edited to be printed. Before printing, you will be given the option to select a printer.

Cursor Movement

<u>Key</u>	<u>Description</u>
Left Arrow	Moves one space to the left.
Right Arrow	Moves one space to the right.
Up Arrow	Moves up one row.
Down Arrow	Moves down one row.
Page Up	Moves up one page.
Page Down	Moves down one page.
Tab	Moves five spaces to the right.
Back Tab	Moves five spaces to the right.
Char-Insert	Inserts characters at the position of the cursor.
Char-Delete	Deletes the character at the position of the cursor.
Line-Insert	Inserts a row at the position of the cursor.
Line-Delete	Deletes the row at the position of the cursor.

F1 Split Line

Splits the line where the cursor is located. The text from the cursor position to the right will be relocated to a newly inserted line.

This is how to split a line.
With the cursor under the **s** in split press **F1**.
This is how to
split a line. —

F2 Join Line

Joins the line after the line where the cursor is located to the end of the cursor line.

This is how to
join a line.
With the cursor under the **T** in **This** press **F2**.
This is how to join a line.

NOTE: Both lines to be joined must appear in the text window.

F5 Format Text

You must first position the cursor at the line where formatting is to begin. The formatting occurs from the line where the cursor is positioned to the next blank line or the end of the document. The text will be formatted using the left and right margins that are set in the tab line.

F7 Special Functions

Press **F7** to display the following:

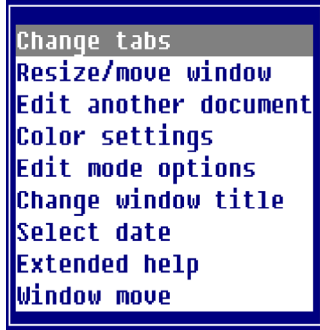

Change tabs

Select **Change tabs**. Any character, except a period, will create a tab stop. The **Period** key and the **Space Bar** enter periods.

<T...T...T...T...T...>

< Sets the left margin.

> Sets the right margin.

T (Or character other than a Period or a Space Bar) sets tab stop.

Use **Up** and **Down Arrow** keys to move the tab line up and down through the text. You can then set margins and tabs for lines to inserted in the text or reformat existing text. To reformat, reset margins and tabs, press **F5**, and press **F4** to exit the **Change tabs** option. The system reformats the text.

Once the left margin is set, using **Change tabs**, you may press **F11** return the left margin to column one for the current line only. For each line that follows, the left margin returns to the **Change tabs** setting.

Resize/move window

Select **Resize/Move Screen**. The system displays the resize box in the lower right corner.

Resize Window

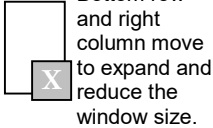
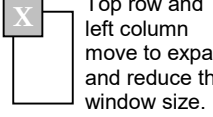
Key \ Mode	 Bottom row and right column move to expand and reduce the window size.	 Top row and left column move to expand and reduce the window size.
Left Arrow Right Arrow Back Tab Tab Up Arrow Down Arrow Page Up Page Down	decreases width 1 column increases width 1 column decreases width 5 columns increases width 5 columns decreases height 1 row increases height 1 row decreases height 5 rows increases height 5 rows	increases width 1 column decreases width 1 column increases width 5 columns decreases width 5 columns increases height 1 row decreases height 1 row increases height 5 rows decreases height 5 rows
Enter Home . (Period) F1 F4 F7	toggle window resize modes. expand to maximum number of rows. expand to maximum number of columns. toggle window resize and window move. terminate window resize and window move. special functions menu.	

Press **F7** to select one of the following options:

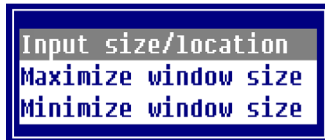

Input size/location

Allows you to change the size of a text window. The window text values display in an input window.



```

78,14,0,7_
    
```

Window Size: 78 columns, 14 rows.

Coordinates: column 0, row 7.

The window size values are columns and rows of text excluding borders.

Maximize window

Expands the window size to the maximum size allowed. The location does not change. The window expands from top to the bottom and from right to left.

Minimize window

Reduces the window size to the minimum size allowed. The contracts from bottom to the top and from right to left.

Move Window

Press **F1** to toggle between resizing and moving the window.

<u>Key</u>	<u>Description</u>
Left Arrow	Moves to the left 1 column.
Right Arrow	Moves to the right 1 column.
Back Tab	Moves to the left 5 columns.
Tab	Moves to the right 5 columns.
Up Arrow	Moves up 1 row.
Down Arrow	Moves down 1 row.
Page Up	Moves up 5 rows.
Page Down	Moves down 5 rows.
Enter	Toggle window resize modes.
Home	Expand to maximum number of rows.
. (Period)	Expand to maximum number of rows.
F1	Toggle window resize and window move.
F4	Terminate window resize and window move.

Edit another document

Enter the name of a file (including the full path), Dictionary-IV Help definition name (llhhhhh), or a Source-IV source name (.llll.ssssss).

NOTE: Dictionary-IV editor function keys are context sensitive. If you enter a Source-IV Source Editor, the function keys perform differently from those in the Text Editor. For more information see to the Source-IV Reference Manual.

If the file or document is found, the contents will be displayed and you may continue editing.

Document Names

- llddddd specifies a Dictionary-IV help definition in library ll.
- .llll.ddddd specifies a Source-IV document in library llll.

Files

- /usr/lib/doc1 specifies a UNIX text file doc1 in the UNIX directory /usr/lib.
- \TBSC\DOC1 specifies a Microsoft Windows text file DOC1 in the Microsoft Windows directory \TBSC.
- D:\TBSC\DOC1 specifies a Microsoft Windows text file DOC1 in the Microsoft Windows directory D:\TBSC.

Cut/paste

- / <> specifies a view of cut text blocks. From this view cut text blocks can be selected, deleted, or edited.
- / <> 3 specifies cut text block 3.
- / <> C specifies that all saved cut text blocks are to be cleared. This option along with the cut text block view delete option should be used to minimize the number of cut text blocks loaded in memory.

Document Lookup

- **F2** displays Dictionary-IV Help definitions for all libraries.
- ll **F2** displays Dictionary-IV Help definitions in library ll.
- .**F2** displays Source-IV libraries.
- .ll. **F2** displays Source-IV documents in library ll.
- /usr/lib/ displays files in UNIX directory path /usr/lib.

Color Settings

For information on color settings see **F15** Character/graphic mode Video attributes, graphics.

Edit Mode Options

This window allows characteristics of the editor to be modified. These characteristics include the action of the **Page Up** and **Page Down** keys, graphics, the right margin alignment, and hyphenation features used by the Format Text function (**F5**).

Functions are applied only when you select the **Execute** option. Press **F4** to exit the menu and abandon any changes.

The **X** to the right of a selection indicates that the selection is enabled. Press the **Space Bar** to enable or disable an option.

<Execute>		Exit and apply changes.
Attribute Pg/Up/Down	X	Page Up/Down enabled.
Graphics		Graphics mode disabled.
Right Margin Alignment	X	Right margin text alignment.
Hyphenation	X	Hyphenation enabled.

Attribute Pg Up/Down

X **Page Up** and **Page Down** keys change the current video attribute.

Blank **Page Up** and **Page Down** keys scroll text pages up and down.

Graphics

X Graphics mode (For more information see Graphics Display Attribute).

Blank Text mode.

Right Margin Align

X Right margin text alignment on.

Blank Right margin text alignment off.

Hyphenation

X Hyphenation on.

Blank Hyphenation off.

Change window title

Allows the Help definition description to be changed. This description can optionally be displayed as the window title.

Select date

Places the current date in the text at the current position of the cursor. If the date does not fit on the line, the date moves left of the cursor until the date fits. The date replaces any text on the line.

Various date formats are allowed and can be custom tailored to the users need. The following menu displays:

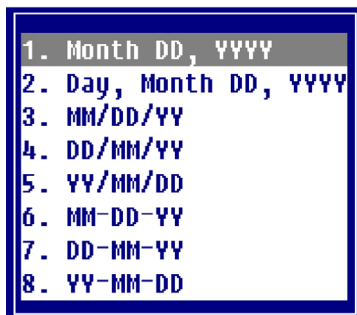

Extended Help

This option supplies on-line help for the following topics:

- On-line Help Summary
- Simple Help Text
- Indexed Help
- Pop-up Menu Help
- Function Key

Window move

Select **Window Move**. The system displays the move characters in the lower right corner (<- - ->).

<u>Key</u>	<u>Description</u>
Left Arrow	Moves to the left 1 column.
Right Arrow	Moves to the right 1 column.
Back Tab	Moves to the left 5 columns.
Tab	Moves to the right 5 columns.
Up Arrow	Moves up 1 row.
Down Arrow	Moves down 1 row.
Page Up	Moves up 5 rows.
Page Down	Moves down 5 rows.
Enter	Toggle window resize modes.
Home	Expand to maximum number of rows.
.(Period)	Expand to maximum number of rows.
F1	Toggle window resize and window move.
F4	Terminate window resize and window move.

F8 Search and Replace

When you press **F8** the system displays the following search and replace window:

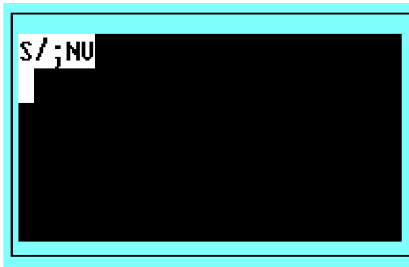

Modify the command line to perform the search or replace.

S searches.

R replaces.

/ defines search and search/replace values.

; defines search/replace pairs of values.

N not case sensitive searches (use C for case sensitive).

V verifies before each replace (use N for no verification before replace).

Use the above to define the type of search (replace) you will conduct. On the following line type the value(s) to search for or to find and replace.

Once the operation is defined you must press **F8** to execute it. Press **F4** to terminate without executing the operation.

Search

Searches the help document for the specified strings.

Examples:

```
s/;CV
fun;games;ready
```

Searches the document and highlights the words fun, games, and ready when they are found. Only lowercase versions of the words will be located. The V (verification) has no meaning for searches.

```
s/;NV
fun;games;ready
```

Searches the document as in the previous example, except all versions of fun, games, and ready will be found regardless of upper or lowercase. The V (verification) has no meaning for searches.

```
s/;NV
fun;games;ready;prepared
```

Searches the document and highlights the words fun, games, ready, and prepared regardless of upper or lowercase. The N in the verify position has no meaning for searches.

Replace

Searches the document for specified strings and replaces all locations with new strings.

Examples:

```
R/;CU
fun/games
```

Searches the document and highlights the word fun and provides option to replace fun with games. Only lowercase versions of the words will be located. Each find must be verified.

```
R/;NU
fun/games
```

Searches the document as in the previous example, except all versions of fun will be found regardless of upper or lowercase. Each find must be verified for replacement.

```
R/;NN
fun/games;ready/prepared
```

Searches the document and highlights the words fun (replacing them with games) and ready (replacing them with prepared) regardless upper or lowercase. The N in the verify position specifies that locations will be replaced without verification.

Commands

Allows you to delete text from the help document.

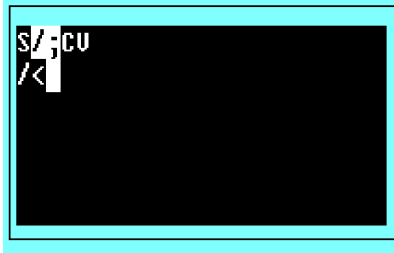

Deletes all text lines from the beginning of the document to and including the line where the cursor is located.

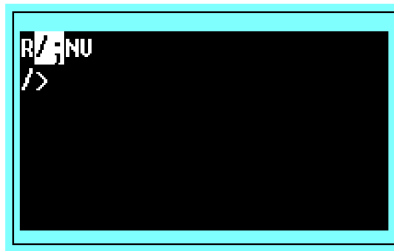

Deletes all text lines from and including the line where the cursor located to the last line in the document.

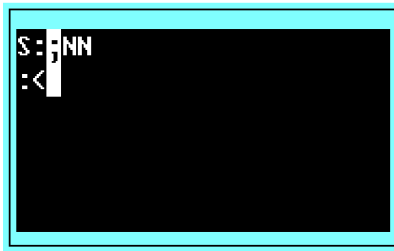

Deletes, as in the first example. The setting of the search-replace delimiter also identifies the command character.

The other option values have no meaning in the command operation.

F10 Goto

Searches the document from the current cursor position (plus one) until a line is found with the Goto value. If a text line is found that contains the Goto value (regardless of upper/lowercase), then the text line will be displayed at the top of the text window. If the Goto value is not found, the text window is not redisplayed. Press **F4** to end the function.

Examples:

“Hello”

Stops at the line that contains hello in upper lowercase.

“Hello”

Stops at the line that contains “hello” in upper or lowercase.

100

Goes directly to text line 100. If you are program text, a Goto program line 100 is done. If you are using the line option, the Goto terminates after positioning to the line you request.

F11 Margin

If the left margin is set to column one (flush left), press **F11** to reset the margin to the current cursor position. If the left margin is set to a column other than one (flush left), press **F11** to reset the margin to column one. If you position the cursor at column one and you are editing a UNIX text file, a continuation character (background colon :) displays. This allows text lines longer than the window line to be stored as one record.

F12 Copy

The following is a description of the copy command:

Position the cursor at the line in front of where the copied text will be inserted (or on top of where the copied text will be overlaid).

Enter the name of the document you wish to copy. If the document exists, it will be displayed and you will be allowed to edit the document. If the document is a cut text block, you will be given the option to save the changes. If the document requested does not exist, then the copy request will be canceled.

You will be given an option to insert or overlay the copied document.

Document Names

Enter the name of a file (full path), Dictionary-IV help name (llhhhhh), or a Source-IV source name (.llll.sssssss).

If the file or document is found, the contents will be displayed and you may continue editing.

Document Names

- lldddddd specifies an Dictionary-IV help definition in library ll.
- .llll.dddddddd specifies a Source-IV document in library llll.
- /usr/lib/doc1 specifies a UNIX text file doc1 in the UNIX directory /usr/lib.
- \TBSC\DOC1 specifies a Microsoft Windows text file DOC1 in the Microsoft Windows directory \TBSC.
- D:\TBSC\DOC1 specifies a Microsoft Windows text file DOC1 in the Microsoft Windows directory D:\TBSC.

Cut/paste blocks

- / <> specifies a lookup of cut text blocks. From this lookup cut text blocks can be selected, deleted, or edited.
- /<> 3 specifies cut text block 3.
- /<> C specifies that all saved cut text blocks are to be cleared. This option along with the cut text block view delete option, should be used to minimize the number of cut text blocks loaded in memory.

Document Lookup

- **F2** displays Dictionary-IV help definitions for all libraries.
- ll **F2** displays Dictionary-IV help definitions in library ll.
- .**F2** displays Source-IV libraries.
- .ll. **F2** displays Source-IV documents in library ll.

F13 Cut and Paste

The Cut and Paste function allows text to be cut from one place in document and pasted in another (in the same document) or saved in memory. Cut text can be modified and/or saved for later use in editing sessions. See the Edit/Save option.

NOTE: The cut text can be pasted back in the original position, as well as being pasted in another place.

Once text has been cut, the cut text will be retained for pasting until **F4**, **F5**, **F7**, **F8**, **F12**, **F14**, or **F16** is pressed.

Cut Text

To mark the text that is to be cut, move the cursor to the start of the cut area and press **F13**. / <Cut? displays in the lower right corner of the window.

Move the cursor to the end of the cut area and press **F13** again. / <Cut> displays in the lower right corner of the window. The cut text will be removed from the document and the cursor will be positioned at the start of the area that was cut.

When a cut is terminated by pressing **F15** the Character/Graphic mode is activated. The display attributes and/or the colors of the cut text can be modified. Press **Enter** from the edit mode window to automatically overlay the cut text. See the display attributes and color section later in this section.

If the cursor is placed at the left-most margin of a line when the cut is started and ended, then it will be assumed that entire lines are being cut. Otherwise, it will be assumed that the start and end cuts are the top left and bottom right of a cut area.

Paste Text

To paste cut text back into its original position, press **F13** after the text has been cut.

To paste text in another position of the document, move the cursor to the desired position and press **F13**. The text can be pasted in as many positions as required. Each time text is pasted you will have the option to insert, overlay, or edit/save the cut text.

Insert will insert the cut text in front of the cursor line. Overlay will paste the cut text on top of the cursor column/row and subsequent rows for the length of the current text. Edit/Save will allow the cut text to be edited prior to pasting or saving the cut text.

Delete Cut Text

Press **F3**, **F4**, **F5**, **F7**, **F8**, **F12**, **F14**, or **F16** to delete the cut text. Once cut text has been deleted, another cut text block can be defined.

Edit/Save Cut Text

The cut text can be edited or saved by pressing **F13** and selecting the **Edit/Save** option.

After the desired edits are made, the edited text can be saved in memory. Each cut text block will be given a sequential number starting at one. Saved cut text blocks can be accessed by any editing session prior clearing the cut text (/ > C).

Position the cursor where you want to insert or overlay the text. Press **F12** and type / >n, where n is the number of the cut text block. Press **Enter** and the cut text block appears at the top of the screen. Press **F4** and select **Insert**, **Overlay**, or **Edit/Save**.

To display the existing cut text blocks press **F12**, type / >, and press **F2**. The system displays the cut text blocks and you may select one from this listing.

F14 Undo

Undoes the last changed, deleted, or inserted line of text for the current editing session.

Continue to press **F14** to Undo modifications made during the current session, until the document has been restored to its original state.

If many modifications have been made and you want to restore the document to the original state, it is not necessary to undo each modification. Exit without saving, and then reload the document. If you make modifications to a line and delete the line without saving, pressing **F14** restores the line to the original state.

NOTE: The maximum size of the Undo string is 64K characters. When the Undo string size reaches 32K a warning prints in the window border (**F14 = nnnnn || 64000**). When the Undo string size reaches 60000 characters, all function keys (except **F7** and **F14**) will be treated as a request to end and save the text). If the Undo string size is exceeded after these warnings, a system error will occur and the editing session will be lost.

F15 Character/Graphics Mode Video Attributes, Graphics, and Color

Use this function to specify the text and background attributes to be used in the window and, if you are using a properly configured color terminal, the use of foreground and background color.

If you are operating on a black and white terminal:

- You can only select the window attributes (any combination of reverse video, underscore, background, and blink).

If you are operating on a color terminal:

- You can select the window attributes (any combination of reverse video, underscore, background, and blink).
- You can select from up to 16 colors for the text foreground and background on your custom screen. You can only select colors if the Save Color Maps have been enabled in Installation Information. For more information see Installation Information in the Dictionary-IV Administrator Guide.

The window attributes and colors should be set before entering text or codes. To change them for text already entered, you must select window attribute and/or color then type over the existing text.

Press **F15** and the system displays the following:



You may toggle Reverse Video, Background, Underline, Blink, Graphic, and Color on and off from this option. Once you make your selection select **<Execute>**.

A status bar appears at the bottom of the screen that displays currently selected attributes.

Window Attributes

The window attributes available are:

None



Full intensity characters.

Reverse Video



Full intensity background (area around characters).

Background



Half intensity (can be characters or background).

Blink



Blinking area of screen.

Underline



Underscored area of screen.

These attributes may be used in any combination providing 16 different combinations.

It is important to remember that underscore and blink are not supported by all terminals.



Foreground



Background

Set your default window attributes in the Window Configurator. For more information see Window Configurator in the Dictionary-IV Administrator Guide.

Foreground/Background Color

There are 16 colors available for the Foreground and Background.

These colors display only if the option for Display Default Colors in the Operator Code screen is set to **N**. If this option is not specified or is set to **Y**, the default colors from the color selector will be used when the window is displayed. For more information see Operator Code, Operator Information, and Window Configurator in the Dictionary-IV Administrator Guide.

NOTE: You can only select colors if Save Color Maps has been enabled in Installation Information. For more information see Installation Information in the Dictionary-IV Administrator Guide.

When you make your selections, the system displays a sample at the bottom of the window.

Using Attributes/Color Setting

Keys available in this option are:

- Left Arrow** Moves the lightbar left across the Foreground/Background color.
- Right Arrow** Moves the lightbar right across the Foreground/Background color.
- Up Arrow** Moves the lightbar up from Foreground Background attributes.
- Down Arrow** Moves the lightbar down from Foreground Background attributes.
- F4** Exits and apply the changes.
- F6** Displays on-line help.
- F7** Restores the original attribute/color settings.

Place the cursor where the window attribute or color is to begin. Select the **Attribute/Color Settings** option. The system displays one of following:

Color Terminal

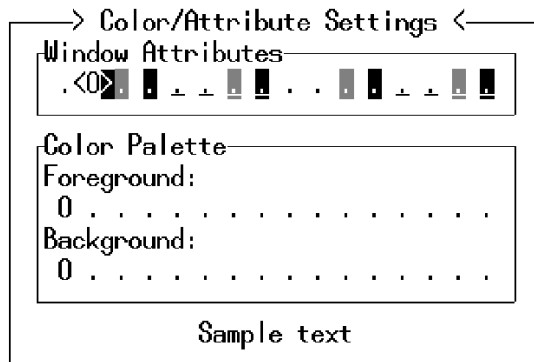

Black and White Terminal

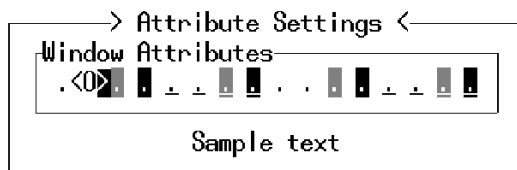

The <0> indicates the current setting. Use the appropriate arrow keys to make your selection. Your selections appear at the bottom of the window as sample text.

Press **F4** to save your selection and exit. Type the text or press **F5** to insert an entry field. The system displays the text or entry field using the attribute/color selection you have chosen.

You may continue using this selection or make another selection. When you save and exit the screen modifications, the system saves the attributes/color selections you made. If you create another screen, the system returns to your default colors.

These default colors are defined in the Window Configurator. For more information see Window Configurator in the Dictionary-IV Administrator Guide.

NOTE: The color attributes cannot be changed if the ability to save the color attributes has been disabled. Once this feature has been disabled, color attributes will be lost when the window is saved. If color text is saved on a non-color terminal, color attributes will be lost when the window is saved.

Character/Graphic Mode

Select this option to toggle between character and graphic mode.

In the character mode, the numbers operate normally. In the graphic mode they create graphic lines.

The following figure shows the numeric keypad in the character mode (left) and in the graphic mode (right).

Character/Graphic Mode

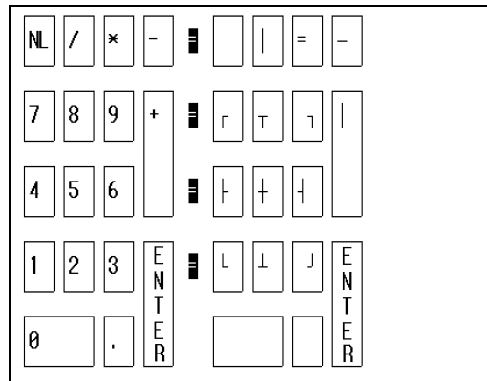

The cursor keys and edit keys still function as in character mode. All other keys are invalid and a “ring bell” will occur if they are used.

Cursor movement will be clockwise after graphic corners are entered and will go in the direction of an intersect graphic character. A graphic center intersect will use the last direction mode.

Delete

Before you can begin to create applications using Dictionary-IV, you must prepare your system. Procedures with which you must be concerned include: creating operator codes, providing security, and system configuration.