

Thoroughbred® Report-IV™ Reference Manual



Version 8.9.0

7 Cedar Grove Lane, Suite 30 • Somerset, NJ 08873
Telephone: 732-560-1377 • 800-524-0430
Fax: 732-560-1594

Internet address: <http://www.tbred.com>

Published by:
Thoroughbred Software International, Inc.
7 Cedar Grove Lane, Suite30
Somerset, New Jersey 08873

Copyright © 2024 by Thoroughbred Software International, Inc.

All rights reserved. No part of the contents of this document
may be reproduced or transmitted in any form or by any means
without the written permission of the publisher.

Document Number: RP8.9.0M101

The Thoroughbred logo, Swash logo, and Solution-IV Accounting logo, OPENWORKSHOP, THOROUGHbred, VIP FOR DICTIONARY-IV, VIP, VIPImage, DICTIONARY-IV, and SOLUTION-IV are registered trademarks of Thoroughbred Software International, Inc.

Thoroughbred Basic, TS Environment, T-WEB, Script-IV, Report-IV, Query-IV, Source-IV, TS Network DataServer, TS ODBC DataServer, TS ODBC R/W DataServer, TS DataServer for Oracle, TS XML DataServer, TS DataServer for MySQL, TS DataServer for MS SQL Server, GWW Gateway for Windows, Report-IV to PDF, TS ReportServer, TS WebServer, TbredComm, WorkStation Manager, FormsCreator, T-RemoteControl, Solution-IV Accounting, Solution-IV Reprographics, Solution-IV ezRepro, Solution-IV RTS, and DataSafeGuard are trademarks of Thoroughbred Software International, Inc.

Other names, products and services mentioned are the trademarks or registered trademarks of their respective vendors or organizations.

INTRODUCTION

Thoroughbred Report-IV is the report generator in the Dictionary-IV family of 4GL products.

It allows you to build reports using non-procedural constructs.

Reports can be directed to a printer, screen, or disk. You can produce report layouts using horizontal and vertical scrolling and screen painting.

Thoroughbred Report-IV can retrieve any data defined in Dictionary-IV. It can select records, sort, and calculate subtotals. The appearance can be controlled using page breaks, headers, footers, boldface, and underscore.

Thoroughbred Dictionary-IV defines the type and location of data items. Report-IV combines data from multiple files, file structures, file systems, and operating systems.

What is Thoroughbred Report-IV

Thoroughbred Report-IV is a comprehensive report writer that produces both simple and complex reports. It is designed to handle all application reporting requirements, reducing the need for the developer to create report programs.

Report-IV generates a printout of data from one or more files defined in Thoroughbred Dictionary-IV. It selects any specific group of records, sorts these records according to the user's specifications, processes each record as needed, calculates subtotals and totals, and prints the end results. Special features for printing include page breaks, headers, footers, special character styles, boldfacing and underscoring.

Report-IV can work with almost any printer's features due to its integration with Dictionary-IV's configurable printer interface tables.

If you prefer to deal strictly with functional and technical information, this manual also serves as a reference. You may wish to read the section in this Introduction on How this Manual is Organized.

The other major components are Thoroughbred Dictionary-IV, Thoroughbred Script-IV, Thoroughbred Query-IV, and Thoroughbred Source-IV. These components have separate manuals to describe their functions fully.

Report-IV provides full screen, free-form screen editing for producing high quality report layouts, and it supports horizontal scrolling for complete on-line viewing of the report layout.

The report definition is composed of several components. First, the report definition header specifies parameters such as the name of the definition and the library where it exists. The first two characters of the definition name designate the library. Other specified parameters include creation date and last change date as generated by the system. Next, the report layout is specified. It is divided into four sections: ENTRY-SECTION, FILE-SECTION, CONTROL-SECTION, and REPORT-SECTION.

ENTRY/FILE/CONTROL/REPORT SECTIONS

```

1-Fmt 2-Scrn 3-View 4-Link 5-Menu 6-Msg 7-Help 8-Gbl 9-Script R-Rpt
REPORT Name: PLRCUST Desc: Customer Database EN
Password: CrDt: 09/19/95 Changed: 09/19/95
Width: 80 <71-248 Type: R <1-Report, 2-Include
F1-Sntx F2-GotoR F3-SetL F4-END F5-Frmla F6-HELP F7-Exe F9-ExpSn F10-DispDN
L-----10-----20-----30-----40-----50-----60-----70
ENTRY-SECTION
FILE-SECTION
CONTROL-SECTION
REPORT-SECTION
H
H LL-RRRRR XXXXXXXXXXXXXXXXXXXXXXXXXXXXXXXXXXXXXXXXXXXXXXXXXXXX Pa
H MM/DD/YY HH
H

```

Each section plays a role in the specification of the report definition:

- ENTRY-SECTION** Specifies the definition of any local Data Names to be included in the report, and Initialization and Termination routines.
- FILE-SECTION** Indicates which Links (Files) are to be used in the report and how they are accessed.
- CONTROL-SECTION** Controls the printing of special lines or report components, specifies controls of totals and subtotals, and conditional page breaks, etc.
- REPORT-SECTION** Lays out the positions of data fields to be printed, specifies formulas, literal text, etc.

Report-IV Benefits

- Thoroughbred Report-IV easily produces reports that would normally require extensive programming, saving you time, energy, and expenses.
- Reports can range from simple lists to complex cross-references of multiple files.
- It is easy to modify and save reports.
- You can create reports for any software application you have, including your accounting system.
- You can create reports that bring together data from different systems.

Report-IV Features

Specific features and capabilities enable Report-IV to:

- Edit and display reports in 132-column mode.
- Create reports from any data file that Dictionary-IV can access.
- Access multiple related data files.
- Access files from a 3GL or 4GL application system.
- Provide special sorting and selection of records.
- Compute data in formulas specified by users.
- Compute totals and/or subtotals.
- Allow specification of controls for indicating conditional or intermittent activities such as special report lines, page breaks, processing, etc.
- Contain extensive formatting features, which include:
 1. headers and footers
 2. ability to incorporate literal text into a report
 3. adjustment of special character attributes including boldface, underscore and point size
 4. table driven interface to take full advantage of special printer functions and features
 5. masking numeric data
- Provides a full screen, free form editor for creating/editing report definitions.
- Contains a complete maintenance system for creating, changing, deleting, copying, renaming, and listing libraries and definitions.
- Offers security to restrict access to the system, to reports and to report components (libraries and/or definitions).
- Provides complete system maintenance utilities including Backup/Restore, Library Maintenance, Printer Table Maintenance, etc.

Report-IV Applications

Report-IV can create many types of reports, from simple listings to more complex reports, which might include multiple links, sort specifications, multiple subtotals, and control breaks. Below are suggested applications for reports:

Lists

Reports from databases that are maintained such as client/customer accounts receivable, and inventory. Other listings that can be produced include mailing labels and phone lists.

Forms

Reports in the format of standard or commonly used forms such as payroll checks, invoices, order forms, and billing statements.

Special Reports

More complex reports, including employee payroll registers, sales analysis, balance sheet, and profit and loss.

Cross Reference

Reports, which sort information such as a client listing, sorted by regional account representative, or a client outstanding invoice listing.

Report-IV Components

Data Files

The base of the reporting system is the file(s) containing the data that will be presented in a report.

Links

To retrieve this data and move it into a report, a map of the data file, a Format is required. Report-IV interfaces with Dictionary-IV Definition Maintenance and uses a Link which points to the Format, the actual data files and secondary sort files to be used with the designated format.

Report Definition

The Report Definition outlines the layout of the finished report. It indicates where data is to be printed, when and where processing will occur, and it specifies headers, footers and other presentation information.

Reports

Finally, the report itself is produced. It may be output to a screen, printer, or file.

The Link(s) specified in the report definition contains file information such as format name, data file, and sort file.

Report-IV Components

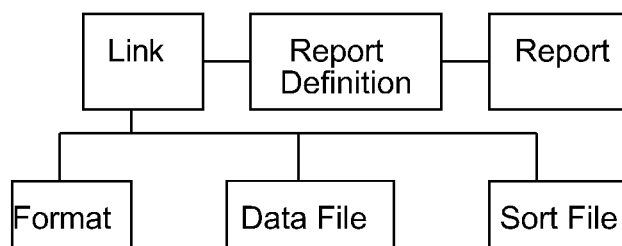

For more information

... about creating applications, refer to the Thoroughbred Dictionary-IV User Guide.

... about software conventions and databases, refer to the Dictionary-IV User Guide.

... about using each Dictionary-IV product, refer to the individual product reference manual (Query-IV, Script-IV, and Source-IV Reference manuals).

... about Thoroughbred Basic Utilities refer to the Thoroughbred Basic Utilities Reference Manual.

... about Thoroughbred Basic, refer to the Thoroughbred Basic Reference Manual.

CREATING REPORTS

The following sections describe how to use Report-IV to create a report.

Introduction

The Report-IV software is integrated with the Dictionary-IV module of Dictionary-IV that allows users to access options from Dictionary-IV menus. This section describes the options from the Dictionary-IV Development Menu that apply specifically to Report-IV.

Dictionary-IV Development Menu

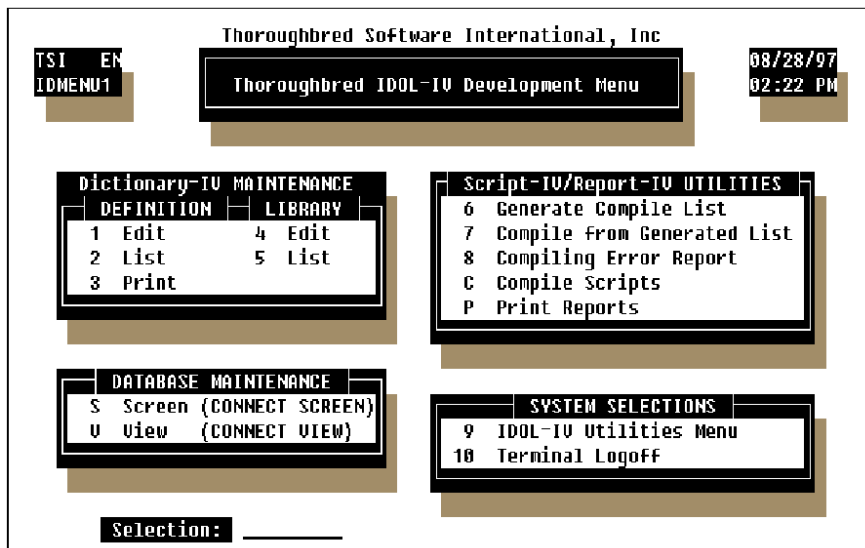

The following options are covered:

Definition Maintenance Edit Definition
 List Definition
 Print Definition

Library Maintenance Edit Library
 List Library

Executing Reports Print Reports

Definition Maintenance

The following subsections describe how to maintain the record definition.

Maintenance Options

Definition Maintenance can be selected from the Dictionary-IV Development Menu. The definition maintenance options are:

- Edit
- List
- Print

Edit allows you to add, change, delete, rename, and copy definitions. List provides a listing of definitions and information about the definitions. Print provides a hard copy of the definition.

Definition Names

A report definition consists of a two-character library name and a report definition name.

Example:

UTCUST

UT designates the library name; **CUST** is the name of the report definition.

Definition names can be from three through eight characters long. The names must be at least three characters long because the first two characters specify the library name. Libraries organize definitions into convenient associations.

Valid characters are alphanumeric:

ABCDEFGHIJKLMNOPQRSTUVWXYZ
abcdefghijklmnopqrstuvwxyz
0123456789

Edit Definition

Custom report definitions are created and maintained using Dictionary Maintenance, also referred to as Definition Maintenance. The report definition is one of several types of definitions that are maintained through Dictionary-IV maintenance in the System Dictionary. Each definition type contains different information, but the method of maintaining the information is consistent for all definitions.

How to Execute

Begin at the Dictionary-IV Development Menu and select **1-Edit** Definition or press the **F1** key from any Dictionary-IV menu. The system displays the following Dictionary-IV pop-up menu:



At the pop-up menu select **R-Reports**. The system displays a View similar to the following:

F1 - Edit F2 - Execute F3 - Print (Change name) - Allows Copy or Rename.

> Report View <

Report Name	Report Description	R	Rep	LastChng	LastPrnt	Cre	
		T	Uld	Pud	Date	Date	D3
4GLCER	SCRIPT-IV Compile Error Listing	R	80	07/17/96	12/12/97	02/1	
IDAUDIT	IDOL-IV Audit Report	R	80	10/26/94	06/18/96	01/1	
IDPRTMNT	Printer Table Maintenance Hard Copy	R	80		06/18/96	08/0	
IDROPER	Operator Listing	R	80	11/10/97	11/12/97	11/0	
IDRPER	REPORT-IV Phase Error Listing	R	80		06/18/96	02/1	
IDRSRT1	Sort Rebuild Log Report	R	93	08/01/95	05/15/97	12/2	
IDRSTART	New Report Definition Skeleton	I	80	05/16/94	06/18/96	05/2	
IDRSTAT1	IDOL-IV Operator Statistics Report	R	128	09/05/95	06/18/96	01/2	
DEQRY1	SAMPLE Q 1	R	132	03/16/94		02/0	
DERCUST	Sample System - Customer Listing	R	80	08/02/96	11/17/97	08/2	
DERINVD	Sample System - Invoice Detail List	R	80	02/15/96	11/12/96	11/1	

Retrieving the Next Definition

From the View above pressing the **Down Arrow** key to highlight the next definition and pressing the **Enter** key selects that definition. When you select a definition from the View you can press **F1** to edit, or press **F2** to execute, or press **F3** to print the report definition. You can also add, change, delete, rename, or copy a definition from the View. See the appropriate sections for more information.

Moving through the Definition View

The **Page Up** and **Page Down** keys can be used to move quickly through the report definitions. These keys are active in all the View definitions. This feature is commonly used to get quickly to the Report Editor without stopping at each View field.

Keys Available in the Report View:

You can scroll vertically among the names, and you can then select a highlighted definition by pressing the **Enter** key. The following special options are available at the list:

Enter	Selects the highlighted definition.
Up Arrow	Moves up one line.
Down Arrow	Moves down one line.
PgUp	Scrolls up one whole View.
PgDn	Scrolls down one whole View.
Home	Goes to: 1. Report name if on another column, 2. First name on screen, 3. Last report name, 4. First name on screen, First report name.
F10	Goes to a specific definition. Prompts for a key value (name) to start the list.
F4	To exit.

Automatic Library Creation

The add, change, rename, and copy modes of Definition Maintenance allow you to create a new library without using Library Maintenance. If you enter a definition name, and the library does not exist, the system prompts:

Do you want to create this library name?

The system displays the following:

```
Creating library:      'xx'  
Library description:  XXX:DD-MMM-YEAR  HH:MM:SS  
Library owner:      owner-name
```

Select one of the following:

Y You may type the Library description and press **Enter**. The system creates the Library.

N Returns to the report name field without creating the library name.

Maintenance Options

Standard maintenance options for report definitions are: Add, Change, Delete, Rename, and Copy. See the following sections for details on each of the maintenance options.

Add

To add a definition name press **Line Insert** from the Report View. Enter a definition name from three through eight characters long. If you enter a name and the library does not exist, you will be allowed to create the library automatically.

If you enter a new name, you are adding a new definition. If you enter an existing name, the system will display the following message:

A record already exists with the key used to define the record being added to the file. Add request will be denied.

Change

To change a report definition from the Report View select the definition and highlight the field to be changed, type over the information displayed. If you make changes to the Report Name the system displays a window showing the report name and the name the report is being changed to. The system then displays a window with the option to Cancel, Copy, or Rename.

To make changes to the report definition press **F1** – Edit, make the changes, and press **F4** to save the definition or changes to the definition. The following prompt is displayed:

Save report modifications?

Select one of the following:

Y saves the definition.

N does not save the definition.

Delete

To delete a report name from the Report View, highlight the report name and press **Line Delete**. The following prompt is displayed:

Delete Record?

Select one of the following:

Y deletes the definition.

N keeps the definition.

Rename

To rename a definition from the Report View, highlight the definition name and type the new name over the existing name. The system will display a window showing the definition name and the name the definition is being renamed to. The system also displays a pop-up menu with the option to Cancel, Copy or Rename. Select **Rename** to rename the definition.

When you rename the definition, it does not have to remain in the same library. If you rename it to a library that does not exist, you can create the library automatically.

Copy

To copy a definition, select the report definition name from the Report View and type the name to copy to over the text. The system will display a window showing the definition name and the name the definition is being copied to. The system also displays a pop-up menu with the option to Cancel, Copy, or Rename. Selecting **Copy** will copy the definition with the new name and the original definition will still exist.

When you copy the definition, it does not have to remain in the same library. If you copy it to a library that does not exist, you can create the library automatically.

List Definition

This function is used to list definitions.

From the Dictionary-IV Development Menu, select option **2, List Definition**.

Dictionary-IV Development Menu

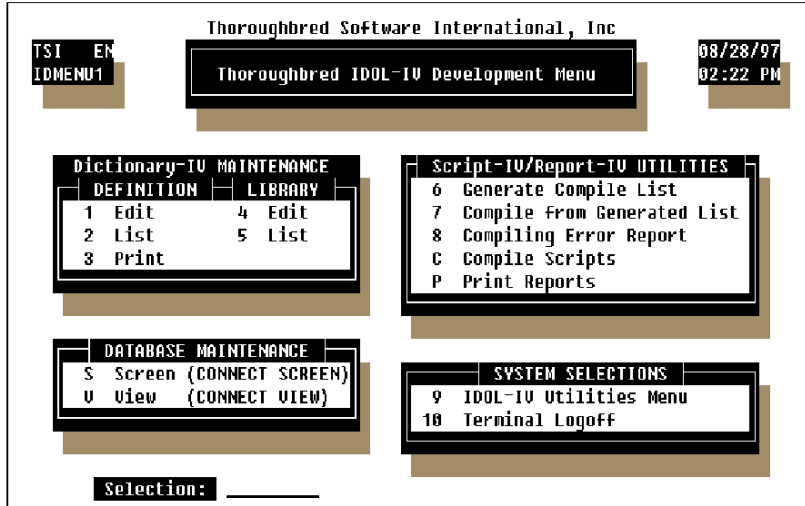

The system prompts:

Do you want a printed copy?

Select one of the following:

Y You are prompted to select the printer if there is more than one configured and a printed copy will be produced.

N A terminal display is produced.

If you select a printed output, the system prompts:

Select printer (xx xx): xx

Select the printer; xx represents a defined printer name for your system. Press **F1** to display a complete list of available printers.

To List Passwords, Enter the System Password:

If security is active, you must enter the system password to obtain a listing that includes definition passwords. The Definition Listing Screen is displayed.

A selector bar enables you to select the category of definitions to list. To list only report definitions, use the **Right Arrow** key to move to **Rpt** for report definition or press the **R** key.

The system prompts:

Library:

Enter the library name for which you want definitions listed.

List all Definitions?

Select one of the following:

Y Lists all definitions in the library for the selected definition type.

N Enables you to specify a range of definitions to list.

from definition: (RETURN for first)
to definition: (RETURN for same or last)

Enter the range of definition names; do not enter the library of the definition. When you select a range of definitions, press the **Enter** key twice to select the first and last definition.

using name mask: (RETURN for none)

A name mask allows you to select definitions without specifying individual names. If you do not wish to use a mask, skip this prompt by pressing the **Enter** key.

A mask sets up a matching test. If a definition name matches the mask, then it is selected. If no match is made, it is skipped. A mask contains match and passing characters. The characters in a report name must match all of the match characters (same character and position) for it to be selected. The pass character (?) is used to indicate that no match in this position is needed.

<u>Mask</u>	<u>Action</u>	<u>Definition Names</u>
A?	selects	AB, AC, A1
	skips	aB, cA, 11

Is the displayed information correct?

Select one of the following:

Y Starts the listing.

N Enables you to change the information.

The Definition Listing includes library information, the definition type, definition name, description, definition creation date, and last change date.

Print Definition

This function is used to print definition reports. Definition reports contain all the specifications for the definition. These reports are used primarily in design of the definitions and as an aid for Definition Maintenance.

From the Dictionary-IV Development Menu, select option **3, Print Definition**.

Select printer (xx xx): xx

Select the printer; **xx** represents a defined printer name for your system. Press **F1** to display a complete list of available printers. The select printer defaults to the default printer setup in Operator Code Record. If none is specified, it defaults to the first printer in the list.

The Definition Report screen is displayed.

A selector bar enables you to select the type of definitions to print. To list only report definitions, use the **Right Arrow** key to scroll to **Rpt** for report definition or press the **R** key.

Library:

Enter the library name for which you want definitions printed.

Print everything?

Select one of the following:

Y Prints all definitions in the library for the selected definition type.

N Enables you to specify a range of definitions to print.

from definition: (RETURN for first)
to definition: (RETURN for same or last)

Enter the range of report names. Do not enter the library of the definition. When selecting a range of definitions, press the **Enter** key twice to select the first and last definition.

using name mask: (RETURN for none)

A name mask allows you to select definitions without specifying individual name. If you do not wish to use a mask, skip this prompt by pressing the **Enter** key.

A mask sets up a matching test. If a definition name matches the mask, then it is selected. If no match is made, it is skipped. A mask contains match and passing characters. The characters in a report name must match all of the match characters (same character and position) for it to be selected. The pass character (?) is used to indicate that no match in this position is needed.

<u>Mask</u>	<u>Action</u>	<u>Definition Names</u>
A?	selects	AB, AC, A1
	skips	aB, cA, 11

Is the displayed information correct?

Select one of the following:

Y Starts the printing.

N Enables you to change the information.

The definition report includes definition name, description, definition creation date, last change date, and detailed information on the report definition.

To Interrupt Printing

If at any time you want to interrupt the printing, press the key sequence for your terminal that represents the **Escape** key; you will be asked if you want to interrupt the printing and must then verify the interrupt.

Printing Reports

Your report can be printed to the terminal screen or output to a printer. Reports can be printed individually or in batches.

To Print a Single Report

To print a report, you must be at the Selection prompt at any Dictionary-IV menu. Type **.report-name**.

Note: The **.** (period) must precede the name of the report that you are printing.

The system prompts:

Do you want a printed copy?

Select one of the following:

Y You are prompted to select the printer and a printed copy will be produced.

N A terminal display is produced.

If you select a printed output, the system prompts:

Select printer (xx xx): xx

Select the printer; **xx** represents a defined printer name for your system. Press **F1** to display a complete list of available printers.

Example:

LP

Note: You can also print a single report from the Report View by pressing **F3** – Print, or from the batch reports section below by selecting the same report name in the from report field as the to report field.

To Print a Batch of Reports

From the Dictionary-IV Development Menu, select option **P, Print Reports**.

The system prompts:

Do you want a printed copy?

Select one of the following:

Y You are prompted to select the printer and a printed copy will be produced.

N A terminal display is produced.

If you select a printed output, the system prompts:

Select printer (xx xx): xx

Select the printer; **xx** represents a defined printer name for your system. Press **F1** to display a complete list of available printers.

Example:

LP

The Print Reports screen is displayed:

Library:

Enter the library name for which you want to print reports.

Select everything?

Y Prints all reports from the selected library.

N Enables you to specify a range of reports to print.

from name: (RETURN for first)
to name: (RETURN for same or last)

Enter the range of report names. Do not enter the library name as part of the report definition name. When selecting a range of definitions, press the **Enter** key twice to select the first and last definition.

using name mask: (RETURN for none)

A name mask allows you to select definitions without specifying individual names. If you do not wish to use a mask, press the **Enter** key.

A mask sets up a matching test. If a definition name matches the mask, then it is selected. If no match is made, it is skipped. A mask contains match and passing characters. The characters in a format name must match all of the match characters (same character and position) for it to be selected. The pass character (?) is used to indicate that no match in this position is needed.

<u>Mask</u>	<u>Action</u>	<u>Definition Names</u>
A?	selects	AB, AC, A1
	skips	aB, cA, 11

Is the displayed information correct?

Select one of the following:

Y Starts the printing.

N Enables you to change the information.

THE REPORT DEFINITION

This section is a reference to the Report-IV report definition.

Introduction

This section covers reference information regarding the Report-IV Definition including:

- Report-IV Definition Maintenance
- The Four Sections of a Report-IV Definition
- Screen Header Field Descriptions
- Report-IV Editor Features
- Function Keys
- Components of the Report-IV Definition

Report-IV Definition Maintenance

Select **1-Edit** at the Dictionary-IV Development Menu or press the **F1** key from any Dictionary-IV menu. The following pop-up menu is displayed:

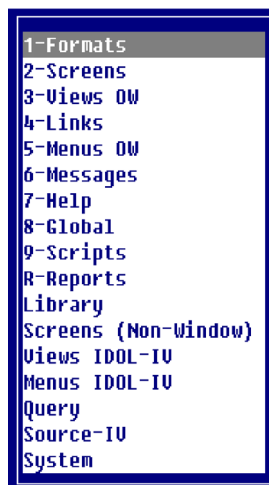

At the pop-up menu select **R-Report**. The system displays a Report View similar to the following:

F1 - Edit F2 - Execute F3 - Print (Change name) - Allows Copy or Rename.						
> Report View <						
Report Name	Report Description	R Rep	I Uid	LastChng Date	LastPrnt Date	Cre Da
4GLCER	SCRIPT-IV Compile Error Listing	R	80	07/17/96	12/12/97	02/1
IDAUDIT	IDOL-IV Audit Report	R	80	10/26/94	06/18/96	01/1
IDPRMNT	Printer Table Maintenance Hard Copy	R	80		06/18/96	08/0
IDROPER	Operator Listing	R	80	11/10/97	11/12/97	11/0
IDRPER	REPORT-IV Phase Error Listing	R	80		06/18/96	02/1
IDRSRTR1	Sort Rebuild Log Report	R	93	08/01/95	05/15/97	12/2
IDRSTART	New Report Definition Skeleton	I	80	05/16/94	06/18/96	05/2
IDRSTAT1	IDOL-IV Operator Statistics Report	R	128	09/05/95	06/18/96	01/2
OEQRV1	SAMPLE Q 1	R	132	03/16/94		02/0
OERCUST	Sample System - Customer Listing	R	80	08/02/96	11/17/97	08/2
OERINVD	Sample System - Invoice Detail List	R	80	02/15/96	11/12/96	11/1

F1 - Edit

From the Report View press **F1** to edit the system displays the Thoroughbred Report-IV Definition Screen:

```

1-Fmt 2-Scrn 3-View 4-Link 5-Menu 6-Msg 7-Help 8-Gbl 9-Script R-Rpt
REPORT Name: PLRCUST Desc: Customer Database EN
Password: CrDt: 09/19/95 Changed: 09/19/95
Width: 80 <71-248 Type: R <1-Report, 2-Include
F1-Sntx F2-GotoR F3-SetL F4-END F5-Frm|a F6-HELP F7-Exe F9-Exp$N F10-DispDN
L-----10-----20-----30-----40-----50-----60-----70
ENTRY-SECTION
FILE-SECTION
CONTROL-SECTION
REPORT-SECTION
H
H LL-RRRRR XXXXXXXXXXXXXXXXXXXXXXXXXXXXXXXXXXXXXXXXXXXXXXXXXXXXXXX Pa
H MM/DD/YY HH
H

```

Custom report definitions are created and maintained using Dictionary Maintenance. Maintenance is an option from the Dictionary-IV Development Menu.

F2 - Execute

To execute a report from the Report View, highlight the report name and press **F2**.

F3 - Print

To print a report definition from the Report View, highlight the report name and press **F3**.

The system prompts:

Print Formulas?

Y prints the report with formulas.

N prints the report without formulas.

Is this correct?

Y prints the report.

N allows you to change the information entered.

Change Name (Copy or Rename)

To change the name of a report definition, from the Report View highlight the name to be changed and type over the existing text. The system will display a window with the definition name and the name the definition is being changed to. It also displays a pop-up menu with the option to Cancel, Copy, or Rename. If you select **Cancel** the system will cancel your request to change the definition name. If you select **Copy** the definition is copied with the new name and also exists with the original name. If you select **Rename** the system completely renames the report definition.

To Add a Definition

To add a definition name press **Line Insert** from the Report View. Enter a definition name from three to eight characters long. If you enter a name and the library does not exist, you will be allowed to create the library automatically.

If you enter a new name, you are adding a new definition. If you enter an existing name, the system will display the following message:

A record already exists with the key used to define the record being added to the file. Add request will be denied.

To Delete a Definition

To delete a report definition from the Report View, highlight the report name and press Line Delete. The following prompt is displayed:

Delete Record?

Y deletes the definition.

N keeps the definition.

For more information on maintenance within the View, see the Maintenance modes section earlier in this document.

Remarks

The report definition is one of many definitions that is maintained by Dictionary-IV during Definition Maintenance (also referred to as Dictionary Maintenance).

The report definition header information provides the specifications for the report definition.

Move the cursor through the fields in the header to enter the report definition editing area.

Available function keys are displayed.

The standard entering and editing keys are active in the fields in the report definition header.

Report Definition Screen Specifications

The following is a description of fields that appear in the *Report-IV* Definition Screen header.

Report Name

This specifies a 3 to 8 character alphanumeric name for the report definition. It can be any combination of letters (A to Z, uppercase and lowercase) or numbers. The first two characters of the name designate the library. This is affected by PRM upper in the IPL File.

Desc

This is an optional entry used to help you identify the definition. The maximum length is 40 characters.

Password

If system security is active and a password (1 to 3 characters) is specified, the password is required in order to edit the report definition. The password restricts other users from performing maintenance on this definition.

CrDt

The system-generated date when the report definition was initially created is automatically inserted in this field.

Changed

The system-generated date when the report definition was last modified is automatically inserted in this field.

Width

The report definition width can be decreased to a minimum of 71 characters or increased to a maximum of 248 characters. The default width is 80 characters.

Type

This designates the report definition type as follows:

- 1 or R** Report - a standard report definition.
- 2 or I** Include - the components of this report definition in another standard report. The include name is specified in the other report definition which will merge or include the components of this definition when the report is compiled.

Features of the Report-IV Definition Editor

Full-screen editor features, with cursor control and function keys for report definitions.

Ability to print the report to the terminal screen or to a printer.

Reports consist of multiple components including text, Data Names from selected databases, special code characters and formulas.

The report width and size can be specified by the user based on the header entry.

Data Names from the specified file(s)/links can be defined or moved to any location on the report.

Special codes can be used to display variable system information such as date, time, and operator code.

Function keys

Available function keys are displayed on the Report Definition screen. This section discusses the operations of the function keys within the report definition.

F1-Sntx Syntax Check

Evaluates the contents of the definition and notifies you of detected syntax errors. Most syntax errors display the associated error message. This function also updates the report workspace.

The syntax check does not check the contents of **F5** formula windows. Syntax in formulas is checked when the formula is saved.

To use new variables defined in the REPORT-SECTION a syntax check must be performed whenever changes are made to the ENTRY-SECTION, FILE-SECTION and/or CONTROL-SECTION.

If an error message does result, press the **F1** key again and the system will display the generated code that is producing this message.

F2-GotoR Go to Right Margin

Scrolls to the right margin of the Report Definition screen. If the display exceeds the width of the report, continue pressing the **F2** key to scroll further to the right.

F3-SetL Set Left Margin

Sets the left margin within the report definition editor. After setting the left margin, press the **Enter** key to return the cursor to the position set by the **F3** key. The **Back Tab** and **left arrow** keys ignore the left margin settings.

To release the margin set by the **F3** key, press the **Home** key.

F4-END End/Exit

Ends the last operation selected or exits the function. After editing the report definition, press the **F4** key to save the report modifications and end the editing session.

F5-Frmla Formula Window

Displays a formula window, where you can enter Data Names, calculations, etc.

F6-HELP Help/Inquiry

Provides a sophisticated help network allowing you to perform inquiries on Dictionary-IV components or obtain information about syntax.

F7-Cpl Compile

Provides the option to compile and run the report. When **F7** is pressed the system prompts:

Do you want to save and compile?

If **Y** is selected the system prompts:

Do you want a printed copy?

F9-ExpSn Expand Screen

Allows screen expansion while editing reports. Options are:

Horizontal Toggles between 80 and 132 character mode. This is available if your terminal type supports 132-character mode.

Vertical Removes the report heading information and gives the editor 5 additional lines for editing.

Compressed Removes the report heading and sets the terminal to 132-character mode. This is available if your terminal type supports 132-character mode.

Normal Sets the terminal to normal display mode and restores the report heading information.

F10-DispDN Display Data Names

At any location within the report definition, you can select the Data Names associated with the Link(s) specified in the FILE-SECTION and ENTRY-SECTION that you want to appear (printed as text) in the report definition. Position your cursor where you want the Data Name to appear as text and press the **F10** key. You can select the Data Names by using cursor control keys. Press the Enter key to select the highlighted Data Name and to reposition your cursor. This feature is useful for specifying column headings, SORT BY and SELECT WHEN clauses, and control breaks.

In the **F10** display window you can press **F7** to switch between Data Name and Data Name descriptions.

Sections of the Report Definition

All report definitions are divided into four sections: ENTRY, FILE, CONTROL, and REPORT.

These section names are recognized by Report-IV and act as commands to define the report definition areas. They must be present in every report definition, even though it is not necessary to complete all sections in every report. If you accidentally delete the section names, retype them in upper-case letters exactly as they appeared.

Special codes and options within each section of the report definition perform various functions and define the layout of the report.

ENTRY-SECTION

Specifies the definition of Data Names to be included in the report, and Initialization and Termination routines.

FILE-SECTION

Specifies which Links are to be used in the report and how they are to be accessed.

CONTROL-SECTION

Controls the printing of special lines or report components, specifies controls of totals and subtotals, conditional page breaks, and so on.

REPORT-SECTION

Lays out the positions of data fields to be printed, specifies formulas, literal text, and so on.

Report Definition Components

Data Fields

The formula window is used to define the location for Data Names or formulas to display or print on the report. Formula windows may contain different types of information. One type is a single Data Name. The other is an expression or formula computed with or without file data. The Report Definition screen holds the place of the data field length to print by displaying *X* characters for string or mixed data, masking characters for date or numeric data, *?* for a conditional formula, or the literal strings.

In the formula window you can press **F10** for a lookup of Data Names. The lookup can be displayed using either the Data Names or the Data Name descriptions of the current language. Press **F7** will toggle between a display of the Data Names and the Data Name descriptions.

NOTE: For more information on accessing the formula window, refer to the Add a formula section later in this document.

When selecting a Data Name from the Data Name View, the corresponding Data Name will be used to populate the formula. All references to Data Names must use the Data Name, not the description.

For more information on Multi-Language, see the Dictionary-IV Administrator Guide.

Literal Text

Text that is printed directly on the report such as headings is entered in the REPORT-SECTION.

Report Commands

Report commands or functions are specified on a command line, within a formula or in a conditional line.

Valid commands or functions are displayed below:

Code	Function
/CTR	Center data to print
/EJECT	Page break; form feed
/EJECTnn	If less than nn text lines are available on the page, then eject. This function prevents related data fields from breaking across pages.
/FIELD(nn)	Temporary area that specifies the actual number of characters (nn) to print for specified Data Name(s)
/LC=n	Set line count to n lines. To retrieve current line count use n=/LC

Code	Function
/LINES (n)=<i>dataname</i>	n — number of text field lines to print. START =string-expression — start with line containing string-expression END = string-expression — end with line containing string-expression
/O	Omit line if blank
(/OLS)	Omit leading spaces
(/OTS)	Omit trailing spaces
/P	To change page character.
/PC=<i>mnemonic</i>	Set printer mnemonic defined in the printer table. Example: /PC=ULON For more information,, see the Dictionary-IV Administrator Guide
/PN=<i>n</i>	Set page number to n. To change the default page number use /PN=string value where string value is any single quoted character. To suppress page numbers use /PN=" ".
/RL=<i>n</i>	Set report length to n lines
/SKIP	Skip this line
/SPACE	Number of spaces

Special Code Characters

Special code variables, also called /variables (slash variables), designate a specified area in the report definition that stores an assigned string or value. These characters are variable, depending on the report definition. Special code characters are:

/Variable	Purpose
/D	System date, DAY.
/d	Terminal date.
/F	File suffix. For more information on file suffixes, please refer to the Script-IV Developer Guide.
/I	Installation name, centered in a 40-character field.
/i	Terminal identification.
/O	Operator code.
/P or #	Page number. Use the # symbol for Header lines only.
/R	Report name.

/Variable	Purpose
/r	Report title, centered in a 40-character field.
/T	Current time (12 hour, no seconds, AM/PM).
/t	Current time (24 hour).

Comments

Comment lines are designated with an ! (exclamation mark) line type and can be included in the report definition to provide information or identification for the user. Comment lines do not print on the report.

Line Types

Line type codes designate the functional nature of a line in a report. A line type is indicated by a line type designator code, sometimes followed by a number, a command line option or a formula. A line type code is entered at the left margin of the line in the report definition. It may indicate text or data to be printed, or one or more commands to be executed when the report is generated. Line types are:

Section	Line Type	Function
ENTRY-SECTION	DN FN I1nn T9nn	Define Local Data Name(s). Declare Format. Initialize Command. Terminate Command.
FILE-SECTION	LN LNU/LNu LNC LNX LNS	Link Name. Operator Code. Continue Processing. Selection Criteria. Sort Criteria.
CONTROL-SECTION AND REPORT-SECTION	CB CT ST	Control Break. Computed Total Print/Accumulate. Subtotal Break.
ENTRY-SECTION FILE-SECTION, AND CONTROL-SECTION	INCLUDE	Merge or include the name of the report that was designated as an include. Note: Press the Tab key to align the INCLUDE line type directly under the L in the header ruler on the Report Definition screen.
REPORT-SECTION	H D F	Header Line. Detail Line. Footer Line.

Section	Line Type	Function
ALL AREAS EXCEPT: D, H, F, CB, ST, CT LINES IN THE REPORT SECTION ALL AREAS	: ! 	Continue syntax for line type onto the next line. Used in all areas of the report definition. Causes the position and all characters following it on a line to be treated as comments and not to be printed. It is not valid in a formula window.
LINE TYPE MODIFIERS IN REPORT-SECTION	? C /O	Indicates Conditional Line. Command Line. Omit Line if Result is Blank.

ENTRY-SECTION

The ENTRY-SECTION allows you to specify Data Names and commands for executing initialization and termination routines. The defined Data Names are those that are used locally in the report and are not established in a Dictionary-IV format. The initialization and termination capabilities utilize various Report-IV commands and 3GL syntax which allow you to set printer characteristics, set report parameters such as length, assign values to Data Names, execute programs, process messages, etc.

Line Types

The following line types are used in the ENTRY-SECTION:

DN Data Name Declaration

FN Format Name Declaration

I1nn Initialization logic

T9nn Termination logic

Conventions

This section provides information on specifications that can be entered in the ENTRY-SECTION of a report definition. The commands and variables are arranged alphabetically, and the information for each entry is organized in the following way:

FUNCTION

A brief description of the action or purpose of each command or variable.

SYNTAX

An outline of command or variable structure, including syntax and readability options. Parameter choices are detailed directly following the command.

NOTES

Remarks and important information on command or variable syntax and the function of a command or variable in the ENTRY-SECTION.

EXAMPLES

Typical examples of command and variable usage.

Where there is more than one Format for a command, the beginning of each command is shown in boldface letters and the choices are separated by a blank line.

As long as the elements within a command are separated by spaces and fall within the command area of a report, no indentation is required. For readability, the syntax is represented with standard indentation to highlight clauses and options under each command.

Note: For more examples of Report-IV commands, declarations, and variables, see the Sample Reports section later in this document.

DN

Define Data Name

FUNCTION

This line type allows you to define local Data Names to be used in the report.

SYNTAX

DN **Data Name** (*n* [*.p*] [* *x*] | **DATE**) [**Data Name** ...]

Data Name is an alphanumeric Data Name.

n is the field length.

p is the numeric precision to be used (only if the Data Name is numeric).

x is the number of occurrences.

DATE is a keyword.

NOTES

- Press the **F1** key each time the local Data Name is added or changed. This updates the report workspace.
- Data Names defined in this line type are referred to as local Data Names. They should not conflict with Data Names used in the report.
- Local Data Names should not conflict with other Data Names established in the Link(s) defined or with any Thoroughbred Basic directive, variable, function names or Report-IV syntax.
- Local Data Names are most commonly used for special values, operator input, registers, totals, header/footer contents, and so on.
- The **DATE** option defines a 6-character Data Name
- This command establishes only the Data Name. Assignment of values is done using other commands.
- Data Names must not start closer to the left than the "L" in the ruler line.
- The rules for defining the field length for a Data Name within a Format apply to local Data Name fields.
- The Data Name must be 3 through 20 characters long.
- Data Names are alphanumeric characters. Valid characters for the Data Names are:

ABCDEFGHIJKLMNOPQRSTUVWXYZ
abcdefghijklmnopqrstuvwxyz 0123456789

- Hyphens and underscore characters are allowed.
- If multiple Data Names are specified on a **DN** line, each Data Name must be separated by a space or comma.

EXAMPLES

DN REP-CODE (3) MTD-SALES (10.2) YTD-SALES (10.2)

A field length of 10.2 signifies a numeric Data Name (presence of a decimal point in the length), whose total length is 10 characters including the decimal point and any sign, with 2 positions to the right of the decimal place. This field definition can hold values ranging from -999999.99 through +999999.99. Assigning values to these Data Names can be done with Initialization commands or on a command line in the REPORT-SECTION.

FN

Format-Name

FUNCTION

FN is a data declaration command that declares a Format from Dictionary-IV to be used in a report.

SYNTAX

```
FN      format-name [,format-name...]
```

format-name is the name of a Format defined in Dictionary-IV.

NOTES

- Press the **F1** key each time the local Data Name is added or changed. This updates the report workspace.
- This line type has the same effect as declaring all the Data Names in a Format on a **DN** line.
- The **FN** line type allows several local Data Names to be maintained in a Format definition.
- Local Data Names should not conflict with Data Names established in the Link(s) defined or with any Thoroughbred Basic directive, variable, function names, or Report-IV syntax.
- Declaring a Format from Dictionary-IV makes the Data Names accessible to the report.
- Multiple formats can be declared with one **FN** statement as long as the Format names are separated by spaces or commas.
- Declaring a Format name allows a standard set of Data Names to be defined as a Format in Dictionary-IV and to be used in multiple reports. This Format is not meant to be linked to any specific data file.

EXAMPLES

```
FN      UTCUST, UTOPENAR
```

I1nn and T9nn

Initialize and Terminate

FUNCTION

The initialize commands (**I1xx**) allow you to execute procedures before the report is printed. The terminate (**T9xx**) commands allow you to execute procedures after the report is printed. Sample initialization routines include setting **PRECISION** for rounding of decimal values, setting the printer to a designated print mode, setting report parameters, or entering or assigning values to be used in the report. Sample termination routines include setting the printer back to a designated print mode or executing a specific program.

SYNTAX

```
I1nn [Report-IV command] [;Report-IV command...]  
      [;Thoroughbred Basic syntax] [;Thoroughbred Basic syntax...]
```

```
T9nn [Report-IV command] [;Report-IV command...]  
      [;Thoroughbred Basic syntax] [;Thoroughbred Basic syntax...]
```

nn is any number from 01 to 99, which represents the line number.

Report-IV command is a Report-IV command.

Thoroughbred Basic syntax is any valid Thoroughbred Basic syntax.

;
separates the Report-IV command from other commands and/or Thoroughbred Basic syntax.

NOTES

- Initialize commands create actual program lines numbered **101** to **199**; terminate commands are numbered from **901** to **999**.
- Subroutines can be specified on Initialization and Termination lines. Use Thoroughbred Basic commands to bypass these subroutines and to resume normal Report-IV processing when necessary.
- All Reports are CALLED. To run another program from within a Report-IV definition, execute a CALL to a Method, a CALL to a public program, a CALL to “IRPCA0” or another CONNECT REPORT. Doing a RUN program_name from inside a definition is no longer supported. To scan one or more libraries for instances of RUN program_name select the **Report RUN Scan** option from the OPENworkshop Upgrade Administration menu.
- Thoroughbred Basic user-defined functions can be established on Initialization and Termination lines.
- Commands intended to exit a report before normal termination should **GOTO** Termination lines to exit the report as normal.
- To print forms or labels, suppress form feed as follows: Set the report length to 0 and delete header lines. For example:

```
I109 /RL=0
```

If Header lines are present, one form feed is generated and headers will be printed.

EXAMPLES

```
I101      /PC=CW12 /RL=64
I102      PRECISION 4
T901      /PC=CW10
```

Before the report is printed, the first initialize command sets the printer to 12-character pitch with a printer command (**/PC=CW12**), and the report length to 64 lines per page (**/RL=64**). The second initialize command sets **PRECISION** (a Thoroughbred Basic directive) to **4** for rounding to the fourth decimal place (default is **2**). The terminate command resets the printer back to 10-character pitch when the report is complete.

Note: **CW12** and **CW10** are defined in the printer table.

```
DN      START (6) MATCH (4) CONVSN (5.2)
I101    START = "C1"; MATCH (2,3) = "R45"; CONVSN = 34.45
```

This is an example of Data Name assignment using the Initialize command. Assignments using Data Names must be separated by at least one space. Operators in expressions (**= / * - +**) must also be surrounded by spaces. Substring position syntax may be used on either side of the equation.

This demonstrates a series of procedures using Report-IV commands and Thoroughbred Basic commands:

```
DN      START-KEY (6) END-KEY (6)
I101    /RL=45 ;PRINT 'CS',
I102    INPUT @(10,2), "START WITH CUSTOMER #: ", START-KEY ,
:       @(10,3), "END WITH CUSTOMER #: ", END-KEY ,
I103    IF CTL=1 OR END-KEY > START-KEY THEN GOTO 102
:       ELSE IF CTL=4 THEN GOTO 901
```

DN Defines two Data Names, **START-KEY** with a field length of **6** and **END-KEY** with a field length of **6**.

I101 Sets the report length to **45** lines per page using a report command and uses a Thoroughbred Basic command to print a message. Note, a space and a semi-colon (**;**) are used to separate the Report-IV command from the Thoroughbred Basic command.

I102 A Thoroughbred Basic command is used to input values to Data Names. It is important that spaces precede and follow Data Names. Numeric Data Names cannot be used for input statements; only alphanumeric Data Names can be used.

I103 A Thoroughbred Basic command is used to test the assigned Data Name values. The result of testing uses **GOTO** to direct processing to appropriate initialize or terminate lines. If the **F1** key is pressed, or the value in **END-KEY** is greater than the value in **START-KEY**, the processing will go to line **I102** and ask for the start and end keys. If the **F4** key is pressed, the processing will terminate.

FILE-SECTION

The Link(s) specified in the FILE-SECTION bring together, and define in a central location, the definitions and specifications that are needed to control access to specified data files in a report definition. The Link(s) point to a Format that specifies where each data item is physically located in a record. It also shows which Data Names are associated with the data in the file. The Link(s) also contain the Sort patterns defined for the file.

Primary Function of a Link

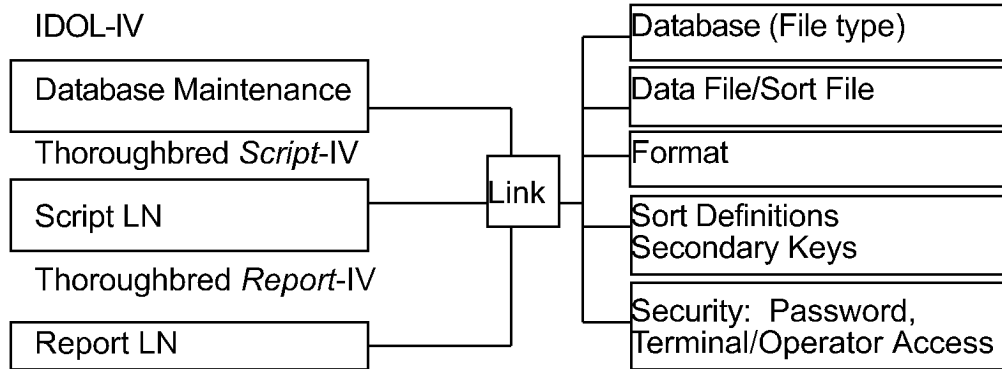

Line types

The following line types are used in the FILE-SECTION:

- LN** Link Name
- LNC** Continue Processing
- LNU/LNu** Reuse Data File Channel
- LNX** SELECT WHEN Criteria
- LNS** ORT BY Criteria

Conventions

This section provides information on specifications that can be entered in the FILE-SECTION of a report definition. The commands and variables are arranged alphabetically, and the information for each entry is organized in the following way:

FUNCTION

A brief description of the action or purpose of each command or variable.

SYNTAX

An outline of command or variable structure, including syntax and readability options. Parameter choices are detailed directly following the command.

NOTES

Remarks and important information on command or variable syntax and the function of a command or variable in the FILE-SECTION.

EXAMPLES

Typical examples of command and variable usage.

Where there is more than one Format for a command, the beginning of each command is shown in boldface letters and the choices are separated by a blank line. In some cases, different command formats are handled in separate sections, e.g., the various options for the LN line.

As long as the elements within a command are separated by spaces and fall within the command area of a report, no indentation is required. For readability, the syntax is represented with standard indentation to highlight clauses and options under each command.

Note: For more examples of Report-IV commands, declarations, and variables, see the Sample Reports appendix.

LN

Link Definition Name

FUNCTION

The **LN** line specifies which Link(s) the report will access, and includes the definitions and specifications that are needed to control access to a specified data file in a report definition.

The primary specifications in the Link are the data file, Format, database type, Sort definitions, and Sort file. The **LN** command makes these specifications available to the report.

When using the **LN** line type for two or more links, the system must find a selected record in subsequent links before printing can take place. If a subsequent record is not found, and a one-to-one relationship exists, the primary record is skipped.

The Link definition:

- Controls how the data file is accessed
- Maintains Sort definitions for the file
- Indicates which Format definition data is to be read into
- Provides security for the data

SYNTAX

LN *LLDDDDDD*

LL is the library name where the Link definition is located.

DDDDDD is the Link name.

NOTES

- Press the **F1** key for a syntax check after specifying the Link name. This is required to update data names available for use in report definition.
- At least one Link must be specified.
- Multiple links can be specified but each Link must be specified on a separate line.
- When more than one Link is specified, the report generated is a joined report. A relationship is established between the two files by a common Data Name or key.
- Data names must not start closer to the left than the "L" in the ruler line.
- If the Link definition cannot be found, make sure that the name is specified and spelled correctly.

EXAMPLES

LN UTCUST

LNC

Continue Processing

FUNCTION

The **LNC** line is used with a secondary Link that continues to read and process multiple links when missing records exist for common Data Names. (Each **LNC** opens one to two logical data file channels and has no impact on key pointers for previous **LN** or **LNC** lines that refer to the same data file.)

SYNTAX

LN *LLDDDDDD*

LNC *LLDDDDDD*

LLDDDDDD is the name of a Link that has the same Data Name as other specified links.

NOTES

- Press the **F1** key for a syntax check after specifying the Link name. This updates the report workspace.
- **LNC** is used when multiple data file channels are open for a single data file.

EXAMPLES

LN **UTCUST**
LNC **UTTERM**
LNC **UTSREP**
LNC **UTSHIP**

This example will open the appropriate four data files on four separate data file channels. If secondary Sort files existed for the data files, they would also be opened resulting in up to eight open data file channels. If **UTCUST**, **UTTERM**, **UTSREP**, and **UTSHIP** all pointed to the same physical data file, the data file read for **UTTERM** would not affect key positioning or processing sequence of the main Link, **UTCUST**. Likewise, if the **UTSREP** read fails to find a proper match, processing will continue with **UTSHIP**. Data will be presented to the REPORT-SECTION for every **UTCUST** record read, regardless of success or failure to find any matching **LNC** records.

LNU/LNu

Reuse Data File Channel

FUNCTION

The **LNU** and **LNu** lines are secondary links that conserve data file channels by opening a single channel when multiple links that share the same data file are specified. The sequence of key pointers is not relevant. This is allowed only if the file is a Multi-Format file, such as a lookup or code file.

SYNTAX

LNU *LLDDDDDD*

LNu *LLDDDDDD*

LLDDDDDD is the name of a Link that has the same data file as a previously specified Link Name.

How LNU Processes Data

- **LNU** continues to read and process multiple links when missing records exist.
- The **LNU** line corresponds to the **LNC** line in its ability to read and process data from multiple links when missing records exist.

How LNu Processes Data

- **LNu** returns to the top file and continues reading when missing records exist and it suppresses printing of data.
- The **LNu** line corresponds to the **LN** line in its ability to read and process data from multiple links when missing records exist.

NOTES

- Press the **F1** key for a syntax check after specifying the Link name. This updates the report workspace.
- Data names must not start closer to the left than the "L" in the ruler line.

EXAMPLES

```
LN      UTCUST
LN      UTTERM
LNU     UTSREP
LNU     UTSHIP
```

The links **UTTERM**, **UTSREP**, and **UTSHIP** share the same physical data-file. The Link **UTCUST** contains these Data Names that are foreign keys (or lookups) to the other files: **TERM-CODE**, **SREP-CODE**, **SHIP-CODE**. Using **LNU** or **LNu**, a single data file channel will be opened.

If **LNU** is used, the system continues to read and process the next specified Link when missing records exist. **LNu** returns to the top file and continues reading when missing records exist. The read function caused by the **LNU** lines will change the physical record pointer of the shared data file. Thus, the next record read for **LN UTTERM** will be determined by the previous record read for **LNU UTSHIP**.

LN~~X~~

SELECT WHEN Criteria

FUNCTION

The **LN~~X~~** line allows you to specify multiple selection criteria from different links.

Use a **:** (colon character as a line type designator for the next line if the commands and/or syntax must continue on the next line.

SYNTAX

```
LNX    SELECT WHEN Data Name [rel-oper value]  
:      conditional-operator value
```

Data Name is a valid Data Name.

rel-oper enables you to specify a portion of the value in a Data Name and describes how one Data Name relates to another.

conditional operator defines the conditions under which records are accessed using operators.

value is a value, which determines whether or not to access data records.

NOTES

- Use **LN~~X~~** for **SELECT WHEN** statements when using multiple links. It is not necessary to use **LN~~X~~** for **SELECT WHEN** statements when Data Names are from the primary data file.
- **LN~~X~~** must be the last entry in the FILE-SECTION unless you use an **LNS** line type.
- The conditional logic can use relational, Boolean and/or logical expressions to establish a true or false condition.
- Data names must not start closer to the left than the "L" in the ruler line.

EXAMPLES

```
LN    UTCUST  
LN    UTSALCD  
LNX  SELECT WHEN CUST-CODE = "009" AND SALES-CODE  
:    ="12345"
```

CUST-CODE is defined in both **UTCUST** and **UTSALCD**, and **SALES-CODE** is defined in the file **UTSALCD**. When **SELECT WHEN** is used in an **LN**, only Data Names specified in that Link can be used.

For more information, see the **SELECT WHEN** section later in this document.

LNS

SORT BY Criteria

FUNCTION

The **LNS** line allows you to specify a SORT expression using Data Names from multiple links.

Use the **:** (colon character) as a line type designator for the next line if the command and/or syntax must continue on the next line.

SYNTAX

```
LNS   SORT BY Data Name|expression  
:  
      [(substring) | (sort order) | (substring,sort order)] [Data Name...]
```

Data Name is a valid Data Name.

expression includes any valid Data Names.

substring specifies part of a Data Name by which to sort.

sort order specifies ascending or descending order:

A specifies ascending order. This is the default.

D specifies descending order.

Data Name are additional Data Name(s) to be included sequentially in the Sort.

NOTES

- **LNS** must be the last entry in the FILE-SECTION.
- Use **LNS** to sort based on data names from multiple links or secondary links. It is not necessary to use **LNS** to sort when all Data Names are present in the primary data file.

For more information, see the SORT BY section later in this document.

EXAMPLES

```
LN    UTCUST  
LN    UTSALCD  
LNS   SORT BY SALES-CODE
```

SALES-CODE is a Data Name located in the secondary file, **UTSALCD**.

```
LN    UTCUST  
LN    UTSALCD  
LNS   SORT BY (BASE-PRICE - ACCTG-COST) / BASE PRICE * 100
```

This Sort is based on the result of a numeric expression using Data Names.

KEY RANGE FROM/TO

FUNCTION

The KEY RANGE option specifies a range of key values to access the records in a keyed file.

SYNTAX

```
LN      LINK NAME      KEY RANGE FROM from-key [TO to-key]
```

from-key specifies the primary key or secondary key in the range to be processed. The default is the first key in the file, or the secondary key if a Sort is selected.

to-key specifies the last key or secondary key in the range to be processed. The default is the last key in the file, or the last secondary key if a Sort is selected.

NOTES

- The key range option is used on the first LN line in the FILE-SECTION.
- Key values can be literal strings or Data Names.
- The actual range of keys processed is from "GREATER THAN OR EQUAL TO" the *from-key* value through "LESS THAN OR EQUAL TO" the *to-key* value.
- When the first Link definition in the report contains a preset key, a key range is automatically generated as the preset key range. In this case, be sure not to put the key prefix in the range.
- When the key range is applied to a **SORT BY** from a predefined sort pattern, the key range is applied to the Sort and must conform in case (uppercase or lowercase) and Sort order (ascending or descending) to the Sort definition.
- When multiple links are specified in the FILE-SECTION, the key preset value, which is specified in the Dictionary-IV Format, determines the selection and the key range of data to be specified.
- This option can only be specified for the first Link when you have multiple file definitions.

EXAMPLES

```
LN      UTSALCD      KEY RANGE FROM "R1C000"
```

This shows the use of a literal string for the starting key value.

```
LN      UTSALCD      KEY RANGE FROM CODE-A TO CODE-C
```

The Data Name **CODE-A** contains the value of the starting key and **CODE-C** contains the value of the optional ending Key. Assignment of a value to Data Names can be done in the ENTRY-SECTION.

SELECT WHEN

FUNCTION

The **SELECT WHEN** option determines whether a record is accessed, depending on defined conditions.

SYNTAX

```
LN      LINK NAME    SELECT WHEN Data Name [(substring) ]  
:      [conditional-operator value] [rel-oper value]
```

Data Name is a valid Data Name.

substring specifies part of a Data Name by which to select.

conditional operator defines the conditions under which records are accessed using operators.

rel-oper enables you to specify a portion of the value in a Data Name and describes how one Data Name relates to another.

value is a value, which determines whether or not to access data records.

NOTES

- The **SELECT WHEN** command follows the same syntax rules of a Thoroughbred Basic **IF** directive, except that the **THEN** and **ELSE** clauses are not allowed. For more information, see the Thoroughbred Basic Reference Manual.
- Substrings can be included as part of the conditional logic expression.
- The Thoroughbred Basic **POS** function can be used to scan a reference string for the occurrence of a specified substring and return a numeric value indicating its position.
- If the first Link definition in the report contains key presets, a **SELECT WHEN** for these values will be generated automatically.
- The conditional logic can use relational, Boolean and/or logical expressions to establish a true or false condition.
- The **SOUNDEX** function, **SDX**, and the **LIKE** relational operator are valid syntax.
- Use a **:** (colon character) as a line type designator for the next line if the commands and/or syntax must continue on the next line.

EXAMPLES

```
LN      UTCUST    SELECT WHEN STATE = "TX"
```

The report will select only customers from Texas, assuming that **TX** is the code for Texas for the Data Name **STATE**.

```
LN      UTCUST    SELECT WHEN CUST-CODE LIKE "F*"
```

The report will select customers if the first character of the Data Name **CUST-CODE** is **F**. The **LIKE** wildcard character ***** selects all data that begins with **F** followed by zero or more characters.

```
LN      UTCUST  SELECT WHEN (CUST-CODE = "001" AND
:      OPEN-AR-BALANCE >1000/.45) OR CREDIT LIMIT = 8000
```

This **SELECT WHEN** condition involves different possibilities using conditional operators. The **AND** and **OR** are processed left to right. Parentheses can be used to force conditional checks.

SORT BY

FUNCTION

The SORT BY option allows you to control the order in which records are accessed.

Use a : (colon character) as a line type designator for the next line if the commands and/or syntax must continue on the next line.

SYNTAX

```
LN      LINK NAME      SORT BY Data Name|expression
:      [(substring) | (sort order) | (substring,sort order)] [Data Name...]
```

Data Name is a valid Data Name.

substring specifies part of a Data Name by which to sort.

sort order specifies ascending or descending order:

A specifies ascending order. This is the default.

D specifies descending order.

Data Name are additional Data Name(s) to be included sequentially in the Sort.

Instead of creating a user-defined Sort, you can specify a predefined Sort from the Link definition. The syntax is as follows:

```
LN      LINK NAME      SORT BY [SORT $n$ ]
```

n is the Sort number defined in the Link.

NOTES

- Single Data Names, constructions, and substrings can be specified.
- The Sort rule constructs the sequence of data items that determine the sorted order.
- The Sort order sequence is based on standard ASCII character values.
- When a **SORT BY** expression is used, **KEY RANGE** and **SELECT WHEN** are applied while sorting so that only selected records are read from the sorted file.
- Numeric expressions can be used in a **SORT BY** clause. The + (plus sign) implies addition rather than concatenation. Therefore, a , (comma) must be used to separate Data Names.
- Sorting can be done in ascending or descending order. The default is ascending when the Sort order is not specified in the SORT definition.
- When using predefined sorts, use the key word SORT plus the Sort number with no spaces in between.

EXAMPLES

LN UTCUST

No Sort is specified, file is accessed sequentially; by **KEY** value for **DIRECT** files and by **INDEX** value for **INDEXED** files. In this case, the **KEY** to the Customer File is **CUST-CODE**, so it is accessed in that order.

LN UTCUST SORT BY CUST-NAME

The file is sorted by the customer's name, as indicated by the Data Name, **CUST-NAME**.

LN UTCUST SORT BY SORT1

The file is sorted by **SORT1** as defined in the Link definition. This sorts in the order that was previously specified in the Link and was referred to as **SORT1**. For additional information on Link Sorts, refer to volume II of the Dictionary-IV Reference Manual..

LN UTCALCD SORT BY (BASE-PRICE - ACCTG-COST) / BASE-PRICE
: * 100)

The file is sorted by the result of this numeric expression.

LN UTCUST SORT BY STATE, CITY, REP-CODE

This is an example of a Sort using more than one data name. The sequence will be sorted by **STATE** first, by **CITY** within **STATE** second, and finally, by **REP-CODE** within **CITY**.

LN UTCUST SORT BY CUST-CODE(2,1,D), YTD-SALES

This illustrates a Sort using a substring, a Sort order (descending) and more than one Data Name. **CUST-CODE** is sorted in descending order based on the second character while **YTD-SALES** is sorted in ascending order.

SORT BY USING

FUNCTION

The **SORT BY USING** option allows you to save the SORT File that is generated when a file is sorted. It can then be used in another report or when the same report is produced again, saving time normally used for sorting.

SYNTAX

SORT BY *expression* [**USING** *file-name* [(**NEW|OLD,DELETE|KEEP**)]]

expression includes any valid Data Names.

file-name is the name of the SORT file to be saved.

NEW erases the specified Sort file and rebuilds the Sort.

OLD opens the specified Sort file without rebuilding the sorts.

DELETE erases the specified Sort file when the report completes.

KEEP does not erase the Sort file when the report completes.

NOTES

- When you have multiple links, this option can be specified for both primary and secondary links.
- Be careful when using existing SORT files since records may have been added to or deleted from the file since it was last sorted and the changes will not be included.

EXAMPLES

```
LN      UTSALCD  SORT BY SALES-CODE(2,1,D) ,  COST-MTD-YTD
:      USING UTCUSFLS (NEW,KEEP)
```

The SORT file generated using the **SORT BY** rule is saved in the **UTCUSFLS** file. The specification **NEW** specifies that when the **SORT** file is generated any previous file with the same name is deleted. **KEEP** specifies that the file is not erased after the report is completed.

```
LN      UTSALCD  SORT BY SALES-CODE(2,1,D) ,  COST-MTD-YTD
:      USING UTCUSFLS (OLD,DELETE)
```

This shows how another report uses the existing SORT file (**OLD**) and deletes (**DELETE**) the file after it has been used.

KEY PRESET VALUES

FUNCTION

When multiple links are specified in the FILE-SECTION, the key preset values that are assigned in the Format will determine the selection and the key range of data to be specified.

NOTES

- Sorting using **KEY PRESET VALUES** is done automatically in Report-IV. Specifications for sorting with key preset values are made in the Format not in a Report-IV definition.

JOIN BY

FUNCTION

The **JOIN BY** option controls the Data Name(s) used to establish the relationship between data in two links. By default, this relationship is based on the first common Data Name in both links. **JOIN BY** allows a different, common Data Name to control this relationship.

SYNTAX

```
LN      LLDDDDDD JOIN BY Data Name [,Data Name...]
```

Data Name is any Data Name common to both links.

NOTES

- The Data Name(s) specified on the **JOIN BY** option must exist in both links being joined.
- Data names must not start closer to the left than the "L" in the ruler line.

EXAMPLES

```
LN      UTCUST
```

```
LN      UTREP
```

```
LN      UTSALHSH JOIN BY CUST-CODE
```

By default **UTSALHSH** would be accessed using the first common Data Name, **REP-CODE**. This example overrides this default, using **CUST-CODE** to access **UTSALHSH**.

DATA-FILE IS/SORT-FILE IS/TEXT-FILE IS

FUNCTION

The **DATA-FILE IS**, **SORT-FILE IS**, and **TEXT-FILE IS** options override the file names contained in the Link. These options can be used when two or more data files have the same Format. You can open a single Link and override the standard data file by reopening the Link with the **DATA-FILE IS** option.

Use a **:** (colon character) as a line type designator for the next line if the commands and/or syntax must continue on the next line.

SYNTAX

```
LN      LLDDDDDD [DATA-FILE IS file name]  
:          [SORT-FILE IS file name]  
:          [TEXT-FILE IS file name]
```

file name is any string expression, which can include quoted string constants, string variables, or data names.

NOTES

- If you override a data file that has a SORT file, then you must specify the SORT file in the **SORT-FILE IS** option.

EXAMPLES

```
LN      UTSALCD  DATA-FILE IS STATE+"SALCD"
```

A single Link, **UTSALCD**, is opened. Instead of accessing the data file specified in that Link, this **LN** causes the data file whose name is comprised of the contents of Data Name **STATE** followed by **"SALCD"** to be accessed. The original Sort file specified in the Link will not be accessed. The original Format in the Link will be used to reference the newly specified data file.

Multi-File Processing

FUNCTION

Multiple links can be specified in the FILE-SECTION of the Report Definition. The data files are accessed according to the sequence of the Link names, their Keys, and any sorting or selecting specified. The first file is read sequentially by Primary or Secondary Key order. If specified Subsequent files are then accessed by either a single read or multiple reads, depending upon the relationship to the previous file.

Every file, except the first, must be related to a previous file. If the previous file is not related, the relationship is established to the closest file listed above it.

The key used to access the file is Secondary key if specified, otherwise it is the Primary key.

Single-Read Access

A Single-Read file operates as a lookup file and can be considered a direct extension of the previous file. The file is accessed once when the previous file is accessed once. This is a one-to-one relationship to the previous file. For example, if the invoice file is followed by the customer file, an invoice record is read and then the customer code is used to read the customer file.

A Single-Read file is established when the entire key is contained in data from the previous files. If the key is **CUST-CODE**, then a previous file must contain the Data Name **CUST-CODE**. If the key is **CUST-CODE + SALES-CODE**, then the previous files must supply both Data Names.

Since Single-Read files are treated as a direct extension of the preceding file, these files should be grouped together under the source file.

EXAMPLE

```
LN      UTCUST SORT BY REP-CODE, CUST-CODE
LN      UTREP
LN      UTSALHSH SORT BY CUST-CODE
```

The customer invoice file is read sequentially by the Secondary key, **REP-CODE + CUST-CODE**. The sales history file is a Multiple-Read file that does a **CUST-CODE** lookup for the invoice file. The representative file is a Single-Read file that does a **REP-CODE** lookup for the customer file.

Multiple-Read Access

A Multiple-Read file is accessed more than once when the previous file is accessed once. For example, if the customer file is followed by the invoice file, a customer record is read and then the customer code is used to read all the invoices for that customer in the invoice file.

In this case, the invoice file is sorted by customer code. Note that fewer reads are performed as compared to the Single-Read relationship described above. This can reduce disk access.

A Multiple-Read file is established when only part of the key is contained in data from the previous files. If the key is **SALES-NUM + CUST-CODE**, then the previous file must contain either **CUST-CODE** or **SALES-NUM** (but not both) in order to be a multiple-read file.

EXAMPLE

```
LN      UTCUST
LN      UTSALCD  SORT BY SALES-CODE,  CUST-CODE
LN      UTSALHSD SORT BY SALES-CODE,  CUST-CODE,
:      INVOICE-NUM
```

The **UTSALCD** Link is read sequentially by the Primary key, **SALES-CODE**. The **UTCUST** Link is a Multiple-Read file in relation to the **UTSALCD** Link because each record in this Link may have more than one record in the **UTCUST** Link. The invoice Link is a Multiple-Read file in relation to the **UTCUST** Link; it may have several records for an individual customer record.

Automatic File Linkage For both Single-Read and Multiple-Read access, the key or part of the key must always be related to a field in one of the previous files.

In cases where the key of the file is not related to the previous file, the system will attempt to build a key that does relate to the previous file. The system will create a Sort file automatically (without specifying the **SORT BY** option), that operates as a Link or bridge between the two files.

The Bridge file is created when the key of the file is not related to a previous file and there are Data Names in the file that are a part of the previous file's key.

EXAMPLE

```
LN      UTSALCD
LN      UTCUST
```

The **UTSALCD** Link is read sequentially by the Primary key (**SALES-CODE**). The system automatically sorts the **UTCUST** Link into sales code order, thus creating a Bridge between the two files (**SALES-CODE**). The same result could be obtained by explicitly specifying **SORT BY SALES-CODE** for the **UTCUST** Link. There must be at least one common Data Name shared by the links specified and the defined length of both fields must be identical.

Missing Records

When using the **LN** line type for two or more links, the system must find a selected record in subsequent links before printing can take place. If a subsequent record is not found, and a one-to-one relationship exists, the primary record is skipped.

Use **LNC** instead of **LN** on subsequent links to continue processing if a record in a subsequent Link is missing.

CONTROL-SECTION

The CONTROL-SECTION defines the conditions for grouping, sub-totaling, and totaling to be used in the REPORT-SECTION.

Line Types

The following line types are used in the CONTROL-SECTION:

CBnn	Control Break
STnn	Subtotal
CTnnA	Computed Total Accumulate
CTnnM	Computed Total (Multiple Accumulators)
CTnnP	Computed Total Print
CTnnE	Conditional Execution

Conventions

This section provides information on specifications that can be entered in the CONTROL-SECTION of a report definition. The commands and variables are arranged alphabetically, and the information for each entry is organized in the following way:

FUNCTION

A brief description of the action or purpose of each command or variable.

SYNTAX

An outline of command or variable structure, including syntax and readability options. Parameter choices are detailed directly following the command.

NOTES

Remarks and important information on command or variable syntax and the function of a command or variable in the CONTROL-SECTION.

EXAMPLES

Typical examples of command and variable usage.

Where there is more than one Format for a command, the beginning of each command is shown in boldface letters and the choices are separated by a blank line.

As long as the elements within a command are separated by spaces and fall within the command area of a report, no indentation is required. For readability, the syntax is represented with standard indentation to highlight clauses and options under each command.

Note: For more examples of Report-IV commands, declarations, and variables, see the Sample Reports appendix.

Logical Conditions

Entries in the CONTROL-SECTION are comprised of a line type, the keyword **WHEN** followed by a logical condition. A logical condition is at least one value consisting of constants, Data Names, or expressions that interact with relational or logical operators to form either a true or false result.

Two special condition indicators are allowed:

WHEN Data Name CHANGES This condition is met when the current value of the specified Data Name changes from its previous value.

WHEN EOF This condition is met when the end of file has been reached.

EXAMPLES

```
WHEN CUST-CODE = "0001"  
WHEN CUST-CODE LIKE "B??Z"  
WHEN CUST-CODE CHANGES  
WHEN CUST-CODE (1,2) = "00" OR CUS-STATE CHANGES  
WHEN REP-CODE = "009" AND YTD-SALES = "200"  
WHEN EOF
```

Subtotals and Computed Total Lines

For subtotals and computed total lines, an additional component of the **WHEN** command can indicate the items that are being totaled by specifying their Data Names.

Subtotal Registers

For subtotals (**STnn**), the values are accumulated in the subtotal registers for each record that is accessed. When a specific subtotal (**STnn**) condition is met, subtotal lines, which correspond to that condition (**STnn**) in the REPORT-SECTION are printed or executed and the subtotal registers are then cleared.

Subtotals are printed in the REPORT-SECTION using subtotal registers and not Data Names.

Computed Total Registers

For computed totals, (**CTnn**), the values are accumulated only when the accumulate condition is met (**CTnnA** or **CTnnM**). Any Computed Total lines (**CTnn**) in the REPORT-SECTION area are printed when the print condition is met (**CTnnP**). This allows different conditions to control printing and accumulating totals. Computed totals are not cleared by either condition, but hold running totals. If necessary, you can reset these totals using commands in the REPORT-SECTION.

Calculated Totals

Calculated totals, like simple totals, can be specified in Subtotal and Computed Total lines. Mathematical expressions can be specified as well as Data Names.

CBnn Control Break

FUNCTION

The **CBnn** line allows you to group data based on the logical condition. Control breaks specify when to process the first record following a condition such as a change in data.

SYNTAX

CBnn WHEN *condition* | *Data Name* CHANGES

nn is a number from 0 through 99.

condition uses valid conditional logic.

Data Name is a valid Data Name.

NOTES

- After adding a **CBnn** line to the CONTROL-SECTION, press the **F1** key to update the report workspace.
- You can specify 100 Control Breaks numbered from **0** through **99**.
- The Control Break categorizes or breaks up data based on the specified Data Name in the CONTROL-SECTION. It is used to control levels of reporting.
- To meet the condition specified, the previous record is compared to the current record.
- The control break lines defined here are used on the corresponding **CBnn** lines in the REPORT-SECTION.
- Data Names must not start closer to the left than the "L" in the ruler line.

EXAMPLES

CONTROL-SECTION

CB01 WHEN INVOICE-NUMBER CHANGES

REPORT-SECTION

CB01 Invoice: XXXXXX

D Invoice Line: XXX

When the value for **INVOICE-NUMBER** meets the conditional logic, the break occurs and the first record following that change is processed. Each time that **INVOICE-NUMBER** changes, Report-IV will print the **INVOICE-NUMBER**.

STnn Subtotal

FUNCTION

The **STnn** line automatically accumulates and clears subtotals on the specified data.

SYNTAX

```
STnn      WHEN condition | Data Name CHANGES ;  
:         [, Data Name [Data Name...]]  
:         [numeric expression]
```

nn a number between 0 and 99.

condition uses valid conditional logic.

;
 separates the conditional logic from the Data Names to be totaled.

Data Name is the data for which a subtotal is registered.

numeric expression is the result of an expression to total.

NOTES

- After adding an **STnn** line to the CONTROL-SECTION, press the **F1** key to update the report workspace.
- You can specify 100 subtotals numbered from **0** through **99**.
- To meet the condition specified, the current record is compared to the next record.
- If no condition is specified the default is **WHEN EOF** (end of file).
- Subtotals will accumulate for each Data Name on the **STnn** line.
- Subtotal accumulators are cleared prior to processing the record, which caused the subtotal break.
- The subtotal accumulates defined here are used on the corresponding **STnn** lines in the REPORT-SECTION.

EXAMPLES

CONTROL-SECTION

```
ST01      WHEN REP-CODE CHANGES ; ACCTG-COST ,  
:         REVENUE-MTD
```

REPORT-SECTION

```
ST01      Total Cost = $###,###.00  
ST01      Total Revenue = $###,###.00
```

This will accumulate totals for **ACCTG-COST** and **REVENUE-MTD** until the value of **REP-CODE** changes. At that point, the **ST01** lines in the REPORT-SECTION will print and the subtotals will be cleared. Processing will continue with the new record that contains the new value of **REP-CODE**.

See also **STnn** in the REPORT-SECTION section of this manual.

CTnn

Computed Total

FUNCTION

The **CTnn** line accumulates computed totals for the specified data.

Use a **:** (colon character) as a line type designator for the next line if the commands and/or syntax must continue on the next line.

SYNTAX

CTnnA **WHEN** *condition*; | *numeric expression*
: [*,Data Name...*] [*,numeric expression...*]

CTnnP **WHEN** *condition*

CTnnM **WHEN** *condition*; *Data Name*|*expression*

CTnnE **Thoroughbred Basic syntax**

nn a number between **0** and **99**.

condition uses valid conditional logic.

; separates the conditional logic from the Data Name.

Data Name is the data for which a total is registered.

expression includes any valid Data Name.

Thoroughbred Basic syntax is any valid Thoroughbred Basic syntax.

NOTES

- The **CTnn** line type can take the following forms:

CTnnA Accumulate

CTnnP Print

CTnnM Multiple Accumulators

CTnnE Execute

- After adding a **CTnn** line to the CONTROL-SECTION, press the **F1** key to update the report work area.
- You can specify 100 computed total breaks numbered **0** through **99**. The numbers cannot be duplicated by the **CTnnM** and **CTnnE** lines.

- The **WHEN** condition must follow the same syntax rules for a Thoroughbred Basic **IF** directive, except that no **THEN** or **ELSE** is allowed.
- The **WHEN** condition can be omitted to select all records.
- Multiple Data Names can be specified (except for **CTnnM**) for which computed totals will register.
- Data names must not start closer to the left than the "L" in the ruler line.

EXAMPLES

```
CT01A    WHEN INVOICE-NUM CHANGES; COMMISS, SALES-AMT  
CT01P    WHEN REP-CODE CHANGES
```

The **CT01A** line specifies that when **INVOICE-NUM** changes, the value of the Data Name **COMMISS** is added in a computed total register and the value of **SALES-AMT** is added in a computed total register. The **CT01P** line specifies that these registered totals will print when the Data Name **REP-CODE** changes.

See also **CTnn** in the REPORT-SECTION.

CTnnM

Computed Totals (Multiple Accumulators)

FUNCTION

The **CTnnM** line provides statistics on the specified data by using various accumulators.

SYNTAX

CTnnM **WHEN** *condition*|*expression*[; *Data Name*]

nn a number between **0** and **99**.

condition uses valid conditional logic.

;
 separates the conditional logic from the expression.

Data Name is the data for which a total is registered.

expression includes any valid Data Names.

NOTES

- After adding a **CTnnM** line to the CONTROL-SECTION, press the **F1** key to update the report work area.
- You can specify 100 multiple accumulators numbered from **0** through **99**.
- Only one value (based on a Data Name or a Data Name expression) can be specified with a single **CTnnM** statement.
- The **WHEN** condition can be omitted to select all records, but the semicolon is required.
- **CTnnM** generates the following accumulators:

CTnn(0) Count

CTnn(1) Total

CTnn(2) Average [CTnn(1)/CTnn(0)]

CTnn(3) Minimum (low value)

CTnn(4) Maximum (high value)

- If the *Data Name* or *expression* is a string (non-numeric), only the 0 entry or count value is maintained and accessible in the REPORT-SECTION.

EXAMPLES

```
CT01M     WHEN SALES-CODE CHANGES; (BASE-PRICE - ACCTG-COST)
CT01P     WHEN EOF
```

The **CT01M** line specifies that when **SALES-CODE** changes, the value of the expression **(BASE-PRICE - ACCTG-COST)** is added in a computed total register. The **CT01P** line specifies that these registered totals will print when the end of file (**EOF**) is reached.

See also **CTnn** in the REPORT-SECTION.

CTnnE

Conditional Execution

FUNCTION

Allows you to manipulate data prior to the total logic or to provide additional read logic.

SYNTAX

CTnnE *condition; executable code; ...*

NOTES

- It supports any report syntax in the CONTROL-SECTION and any Thoroughbred Basic syntax (as long as line numbers are not required). You can have:

```
CALL publicpgn, x$,y$[ ]
CONNECT REPORT ...
WHILE xxxxxxxx WEND
IF xxxxxxxx ELSE xxxxxxxx FI
```

Also at the point where the CONTROL-SECTION logic is executed, the file reads are done and all formats are loaded into memory so the **CTnnE** syntax has access to #formatname.

- The number is the same as any **CTnnA** or **STnn** and cannot be the same as any other **CTnnA** or **STnn**.
- The break section of the statement is the same as currently available for a computed total line.
- The remainder can be any valid Thoroughbred Basic syntax recognized by Report-IV. It will be executed at the time it would have been executed had it been a normal **CTnnA**.
- Data names must not start closer to the left than the "L" in the ruler line.
- If any of the Format data is modified, it should be reassigned. For example:

```
CT00E ;CALL "ANYPUB"; LET LLEFFFFFF = #LLEFFFFFF.
```

This reassigns the data just read and may not be the data that will print by the next detail line.

- Any errors that are caused by the execution are ignored so provision should be made to process any errors.
- The **CTnnE** line can only be defined in the CONTROL-SECTION.

EXAMPLES

```
CT01A WHEN ...
CT02A WHEN...
CT03E CALL...
```

REPORT-SECTION

The REPORT-SECTION defines the report layout. Typical components of this section include data fields, computed formulas, literal text, and commands.

Line Types

The following line types are used in the REPORT-SECTION:

H Header

F Footer

D Detail

CBnn Control Break Line

STnn Subtotal Line

CTnn Computed Total

Each of the above line types can be modified by the following:

? Indicates Conditional Line.

This modifier logically controls the execution of the line. To specify the line type as conditional, press the **F5** key in the position after the line type and enter conditional logic. A **?** character will be appended to the line type designation.

C Command Line.

This modifier allows you to enter Report-IV commands and Thoroughbred Basic syntax. To specify the line type as a command line, append a **C** character to the line type designator.

/O Omit line if result is blank.

This modifier suppresses the printing of blank lines. To specify the line type, append a **/O** to the line type designator.

Conventions

This section provides information on specifications that can be entered in the REPORT-SECTION of a report definition. The commands and variables are arranged alphabetically, and the information for each entry is organized in the following way:

FUNCTION

A brief description of the action or purpose of each command or variable.

SYNTAX

An outline of command or variable structure, including syntax and readability options. Parameter choices are detailed directly following the command.

NOTES

Remarks and important information on command or variable syntax and the function of a command or variable in the REPORT-SECTION.

EXAMPLES

Typical examples of command and variable usage.

Where there is more than one Format for a command, the beginning of each command is shown in boldface letters and the choices are separated by a blank line. In some cases, different command formats are handled in separate sections, e.g., PRINT HELP and PRINT MESSAGE.

As long as the elements within a command are separated by spaces and fall within the command area of a report, no indentation is required. For readability, the syntax is represented with standard indentation to highlight clauses and options under each command.

Note: For more examples of Report-IV commands, declarations, and variables, see the Sample Reports section.

Report-IV Commands

Report-IV commands, also called functions, can be specified either within a formula or directly in the REPORT-SECTION, or both, depending on which command it is and the line type used. Valid Report-IV commands or functions are:

Code	Function
(/CTR)	Center data to print
/EJECT	Page break; form feed
/EJECTnn	If less than nn text lines are available on the page, then eject. This function prevents related data fields from breaking across pages.
/FIELD(nn)	Temporary area that specifies the actual number of characters (nn) to print for specified Data Name(s)
/LC=n	Set line count to n lines. To retrieve current line count use n=/LC

Code	Function
/LINES (<i>n</i>)= <i>dataname</i>	n — number of text field lines to print. START =string-expression — start with line containing string-expression END = string-expression — end with line containing string-expression
/O	Omit line if blank
(/OLS)	Omit leading spaces
(/OTS)	Omit trailing spaces
/P	To change page character.
/PC = <i>mnemonic</i>	Set printer mnemonic defined in the printer table. Example: /PC=ULON For more information, see the Dictionary-IV Administrator Guide
/PN = <i>n</i>	Set page number to n. To change the default page number use /PN=string value where string value is any single quoted character. To suppress page numbers use /PN=" ".
/RL = <i>n</i>	Set report length to n lines
/SKIP	Skip this line
/SPACE	Number of spaces

Report-IV Special Code Characters

Report-IV special code characters, also called /variables (slash variables), can only be specified in a formula window:

/Variable	Purpose
/D	System date, DAY.
/d	Terminal date.
/F	File suffix. For more information on file suffixes, please refer to the Script-IV Developer Guide.
/I	Installation name, centered in a 40-character field.
/i	Terminal identification.
/O	Operator code.
/P or #	Page number. Use the # symbol for Header lines only.
/R	Report name.
/r	Report title, centered in a 40-character field.

/Variable	Purpose
/T	Current time (12 hour, no seconds, AM/PM).
/t	Current time (24 hour).

Formulas Contents

A data field on the report is created by entering at least one Data Name in the formula window. A formula can contain any Data Name referenced in the ENTRY-SECTION or the FILE-SECTION, Report-IV commands, 3GL functions and variables.

The formula window recognizes the types of information described in the following subsections:

Data Names

Enter Data Field	F4-
CUST-CODE	

This formula places the contents of the Data Name CUST-CODE at the location where the formula was entered.

Expressions or Numbers

Enter Data Field	F4-
(BASE-PRICE - ACCTG-COST) * 100 / BASE-PRICE: "###.00%"	

This formula places the results of this computation at the location where the formula was entered.

Thoroughbred Basic Syntax

Enter Data Field	F4-
IF CUST-CODE = "ABC" THEN /SKIP	

This example shows a conditional formula that is specified on the left margin of a non-command line type in the REPORT-SECTION. The question mark indicating the position of the formula will remain after the formula window is closed. This formula makes this a conditional line.

Report-IV Commands

Enter Data Field	F4-
COMMENTS (/CTR)	

The Report-IV command **/CTR** will print the **COMMENTS** centered within the length of the field/variables.

Enter Data Field	F4-
/R	

The Report-IV variable **/R** will print the library and report definition name in the following Format: **LL-RRRRRR**.

/FIELD and Conditional Formulas

/FIELD is used to change the output width of a Data Name. It can also be used within a conditional formula.

SYNTAX

```
[IF condition THEN] /FIELD(length) = value-1  
[ELSE /FIELD(length) = value-2]
```

condition an expression or statement, which is tested, to determine whether or not the formula will be calculated.

length the number of characters used to display the calculated value.

value-1 a Data Name or formula (as described previously) that results in a value.

If the condition is true, this formula displays value-2 in the formula field.

Enter Data Field	F4-
/FIELD(5)=CUST-ZIP	

This will reduce the output of the **CUST-ZIP** field, defined with a length of ten characters to five characters.

Enter Data Field	F4-
IF LEN(CUST-ZIP) (/OTS)=5 THEN /FIELD(14)="SHORT ZIP CODE"	

The Report-IV command **/OTS** will omit trailing spaces for the length calculation. The **/FIELD** command creates a 14-character workspace which holds the string.

Additional Formula Examples

Assume that you want to calculate Gross Profit for an accounting screen. You could define a formula for Gross Profit as follows:

Enter Data Field	F4-
YTD-SALES - YTD-COST	

However, if you want to calculate Gross Profit Percent, you need to divide Gross Profit by the YTD-SALES:

Enter Data Field	F4-
(YTD-SALES - YTD-COST) *100/YTD-SALES	

Note: A field of asterisks indicates an undefined mathematical function, such as division by zero.

Conditional Assignments in a Formula

SYNTAX

value-1; **IF** *condition* **THEN** *Data Name* = *value-2* [**ELSE...**]

value a Data Name or formula (as described previously) that results in a value.

condition an expression or statement, which is tested, to determine whether or not the assignment will be performed.

If the condition is true, this formula assigns *value-2* to the specified Data Name after it prints *value-1*. This type of formula is a combination of a data field (*value-1*) and a conditional assignment. The result of *value-1* is output on the report.

Add a Formula

Use the formula window as follows:

1. Locate your cursor at the position or field where you want the results of the formula to appear and press the **F5** key. The ? on the line in the REPORT-SECTION indicates where the results of the formula will be positioned on the report.
2. Enter acceptable Data Name(s), computations, Report-IV commands or variables, or Thoroughbred Basic syntax. You can press one of the following keys:
 - F4** Exits the formula window without saving or changing your entry.
 - F5** Exits the formula window and saves your entry. This also validates the contents of the formula.

F10 Displays a lookup of Data Names. You can scroll through the list of Data Names using the standard View movement keys. To jump to a selected Data Name in the formula window, press the **F10** key when your cursor is in the Data Name display window. You are prompted to enter a key value to jump to, or press the first character of the Data Name to go to.

Press the **Enter** key to select the Data Name you want to include in the formula window or press the first letter of the Data Name.

Press the **F5** key to close the formula window and save your changes.

Note: The maximum number of formulas allowed in Report-IV is 1024.

Edit a Formula

Locate your cursor at the position where the results of the formula are to be written and press the **F5** key over the portion you want to revise.

Insert, edit or delete the contents of the formula window.

Exit the formula window and save your changes by pressing the **F5** key. If you want to abort the editing and restore the contents of the formula, press the **F4** key to cancel and exit the formula editor.

Errors

If you have entered a nonexistent Data Name or incorrect syntax, pressing the **F5** key to save the data field will result in the following error message:

***Syntax Error, F1 to display, RETURN to continue.**

Press the **F1** key to see the generated line of code. Standard View movement keys are available. Press **F4** to return to the definition window.

If you get this message, check the following:

- Data Name spelling, including hyphens, spaces and capitalization
- Masking formats
- Calculation syntax and logic
- Data field and formula syntax

H and F Headers & Footers

FUNCTION

The line types, **H**, **HC** and **H?** enable you to define page headings to be printed on specified pages or on all pages of the report. The line types **F**, **FC** and **F?** enable you to define page footers to be printed on specified pages or on all pages of the report. Formulas and special commands can be included in the header and footer lines.

SYNTAX

H[?|/O] [*text*] [*formulas*]
HC [*Report-IV command*] [*Thoroughbred Basic syntax*]

F[?|/O] [*text*] [*formulas*]
FC [*Report-IV command*] [*Thoroughbred Basic syntax*]

?	conditional line modifier
<i>text</i>	any text to be output on the line
<i>formula</i>	any Report-IV formula
<i>Report-IV command</i>	any Report-IV commands
<i>Thoroughbred Basic syntax</i>	any Thoroughbred Basic syntax

NOTES

- Report-IV provides default header lines containing the following /variables:
 - /R Library and Report Name totaling 3 to 8 characters.
 - /r The description specified in the Report Definition Header totaling up to 40 characters.
 - # Page number totaling 1 to 3 characters. The # symbol can be used only in a header or footer to indicate page number. Elsewhere, use the variable /P in a formula.
 - /D Date of report printing totaling 8 characters.
 - /T Time of report printing totaling 8 characters.
- There are no limits to the number of header and footer lines you want to specify.
- Header and footer lines can contain text, formulas, /variables, or commands. They can be left blank.
- Quotes (" ") are restricted characters within the entire report definition. One way to print quote characters is to define a Data Name of one character length and set it to **QUO** in the ENTRY-SECTION. Then use a formula to print the Data Name whenever you want to print quotes.

- All header lines must be grouped together and all footer lines must be grouped together.
- It is advisable to place the header lines in the beginning and the footer lines at the end.
- The # symbol is used to print page numbers in a header or footer line, but can be changed using /P.
- Data names must not start closer to the left than the "L" in the ruler line.

EXAMPLES

Note: These examples display the use of header lines but they also can apply to footers by substituting the **H** with an **F**.

HC /PC=CW12

The **C** in the **HC** line allows you to specify a command. Commands can be used to set values, change type styles, and so on. This examples shows a line that sets the Printer to 12 Character Pitch (/PC= is a Printer Code Command).

H? Customers For Salesman: XXXXXXXXXXXXXXXXXXXX - XXXXXX

H? Customer/Salesman Synopsis

These represent two conditional header lines. The line is printed only when a specified condition is met. To set the condition, enter **H**, then press the **F5** key. Enter the conditional syntax in the formula window. The **?** indicates that this line is conditional. In this example, the first header prints in the body of the report and the second on the synopsis page.

Following are the corresponding formulas:

Condition A:

Enter Data Field	F4
IF SLSMN = /SPACE THEN /SKIP	

Condition B:

Enter Data Field	F4
IF SLSMN = /SPACE	

Conditions A and B would be entered in the header conditional lines, line type **H**. Condition A would be used in the body of the report while condition B would be used in the synopsis page.

D

Detail Lines

FUNCTION

Detail lines in the REPORT-SECTION are printed for every record that is accessed.

SYNTAX

```
D[?|/O]  [text] [formulas]
DC       [Report-IV command] [Thoroughbred Basic syntax]
```

NOTES

- Detail lines can contain text, formulas, special code characters (/variables), or commands. They may be left blank.
- Data names must not start closer to the left than the "L" in the ruler line.

EXAMPLES

```
D      XXXXX      ####.00
```

The first series of characters (**XXXXX**) holds the place of a string Data Name. The second series of characters (**####.00**) holds the place of a numeric Data Name.

```
DC     /EJECT3
```

The command **/EJECT n** causes the page to be ejected when three or fewer lines remain for text printing on the current page. This prevents related data from breaking across pages.

CBnn

Control Breaks

FUNCTION

Control break lines are lines in the REPORT-SECTION that are only printed when the condition specified in the CONTROL-SECTION is met.

SYNTAX

```
CBnn[?|/O] [text] [formulas]
CBnnC      [Report-IV command] [Thoroughbred Basic syntax]
```

NOTES

- Control break lines can contain text, formulas, special code characters (/variables), or commands. They may be left blank.
- Control breaks are typically used to group different levels of detail.
- Data names must not start closer to the left than the "L" in the ruler line.

EXAMPLES

```
CB01      Company: XXXX
```

The series of X characters holds the place of a string Data Name.

```
CB01C    /PC=ULOFF
```

The Report-IV command /PC enables users to specify printer control functions. In this example, the underline is set to off.

STnn

Subtotals or Totals

FUNCTION

Subtotal lines are lines in the REPORT-SECTION that are only printed when the condition specified in the CONTROL-SECTION is met.

SYNTAX

```
STnn[?|/O]  [text] [formulas]  
STnnC      [Report-IV command] [Thoroughbred Basic syntax]
```

NOTES

- Subtotal or total lines can contain text, formulas, special code characters (/variables), or commands. They may be left blank.
- If you specify entry zero, **STnn(0)**, in the formula in the REPORT-SECTION, the count of the records processed will print. In a one-to-many condition, this includes each of the secondary records. To process only the primary records use a **CTnnA**.
- Subsequent accumulators correspond to the position of the Data Names in the **ST** line in the CONTROL-SECTION. For example, **STnn(1)** specifies the sum of values for the first Data Name.
- **STnn** can be used in formulas on any line type in the REPORT-SECTION. The WHEN condition of the corresponding **STnn** line controls when the subtotal registers are cleared.
- Subtotals cannot be defined for local Data Names.
- Data Names must not start closer to the left than the "L" in the ruler line.

EXAMPLES

CONTROL-SECTION

```
ST01      WHEN CUST-CODE CHANGES; MTD-SALES, YTD-SALES  
ST02      WHEN EOF; MTD-SALES, YTD-SALES
```

```
.  
. .
```

REPORT-SECTION

```
ST01C     /EJECT3  
ST01      Month To Date Sales = $###,###.00  
ST01      Year To Date Sales = $###,###.00  
ST01      Average Monthly Sales = $###,###.00
```

```
ST01  
ST02      Month To Date Total Sales = $###,###.00  
ST02      Year To Date Total Sales = $###,###.00  
ST02      Average Total Monthly Sales = $###,###.00
```

The above example will keep subtotals for **MTD-SALES** and **YTD-SALES** in two separate sets of accumulators. Whenever **CUST-CODE** changes, the **ST01** lines in the REPORT-SECTION will be executed and the **ST01** accumulators will be cleared. After the last record is read and printed, the **ST02** lines in the REPORT-SECTION will be executed.

Note that a page eject will occur when the number of lines specified in the **/EJECT** will not fit on the page. The end of file, which causes the **ST02** lines to print, will result in an unconditional page eject. Note, also, that a subtotal whose condition is EOF is truly a grand total.

The following formulas apply to the example lines:

Enter Data Field	F4-
ST01 (1) : "\$###,###.00"	

Enter Data Field	F4-
ST01 (2) : "\$###,###.00"	

Enter Data Field	F4-
ST01 (2) / ST01 (0) : "\$###,###.00"	

Enter Data Field	F4-
ST02 (1) : "\$###,###.00"	

Enter Data Field	F4-
ST02 (2) : "\$###,###.00"	

Enter Data Field	F4-
ST02 (2) / ST02 (0) : "\$###,###.00"	

CTnn

Computed Total Accumulate/Print

FUNCTION

Computed total lines are lines in the REPORT-SECTION that are only printed when the corresponding condition specified in the CONTROL-SECTION is met.

SYNTAX

```
CTnn[?|/0] [text] [formulas]
CTnnC      [Report-IV command] [Thoroughbred Basic syntax]
```

NOTES

- Computed total lines can contain text, formulas, special code characters (/variables), or commands.
- If you specify entry zero, **CTnn(0)**, in the formula in the REPORT-SECTION, the count of the records selected will print. In a one-to-many conditions this includes the primary records only. To process secondary records, use an **STnn** line type.
- If you specify **CTnn(1)** in the formula window in the REPORT-SECTION, the sum of the value of the first Data Name in the corresponding **CTnn** line in the CONTROL-SECTION will print.
- Subsequent accumulators correspond to the position of the Data Name in the **CT** line in the CONTROL-SECTION. For example, **CTnn(1)** specifies the sum of values for the first Data Name.
- **CTnn** can be used in formulas on any line type in the REPORT-SECTION.
- **CTnn** accumulators are not cleared.
- Data names must not start closer to the left than the "L" in the ruler line.

EXAMPLES

CONTROL-SECTION

```
CT01A    WHEN INVOICE-NUM CHANGES; TOTAL-COMM, TOTAL-SALES
CT01P    WHEN INVOICE-NUM CHANGES
```

REPORT-SECTION

```
CT01     Total Commission:  $###,###.00  Total Sales:$#####.00
```

The masks above represent computed totals specified in formula windows.

Enter Data Field	F4-
CT01 (1) : "\$###,###.00"	

The mask above represents the Total Commission.

The specifications are made for the second computed subtotal in the formula window:

Enter Data Field	F4
CT01 (2) : "\$####.00"	

The mask above represents the Total Sales.

REPORT-IV COMMANDS

The following section describes Report-IV commands.

Introduction

The following commands can be used in sections other than the REPORT-SECTION:

- **CONNECT REPORT**
- **INPUT MESSAGE**
- **RUN PUBLIC**
- **TERM KEY**

Conventions

This section provides information on specifications that can be entered into a report definition. The commands and variables are arranged alphabetically, and the information for each entry is organized in the following way:

FUNCTION

A brief description of the action or purpose of each command or variable.

SYNTAX

An outline of command or variable structure, including syntax and readability options. Parameter choices are detailed directly following the command.

NOTES

Remarks and important information on command or variable syntax and the function of a command or variable in the FILE-SECTION.

EXAMPLES

Typical examples of command and variable usage.

Where there is more than one Format for a command, the beginning of each command is shown in boldface letters and the choices are separated by a blank line. In some cases different command formats are handled in separate sections, e.g., **PRINT HELP** and **PRINT MESSAGE**.

As long as the elements within a command are separated by spaces and fall within the command area of a report, no indentation is required. For readability, the syntax is represented with standard indentation to highlight clauses and options under each command.

For more examples of Report-IV commands, declarations, and variables, see the Sample Reports section.

CONNECT REPORT

FUNCTION

CONNECT REPORT allows a report to be executed from within another report definition, script, method, etc.

SYNTAX

CONNECT REPORT *report-name*

report-name is a string variable, string constant or Report-IV Data Name. It contains the name of the report to be executed.

NOTES

- All parameters of the current report (page, number, line count, etc.) are passed into *report-name*. This allows two reports to be merged into one common output.
- **CONNECT REPORT** can be used to solve file relationship problems such as several one-to-many relationships, for example:

```
Customer file
  Key: CUST-CODE
Customer Alternate Address file
  Key: CUST-CODE + ADDR-CODE
Customer Contact file
  Key: CUST-CODE + CONTACT
```

For each customer there can be several addresses and several contacts. **CONNECT REPORT** allows a small report of customer addresses and customer contacts to be merged into the output of the main customer report.

- **CONNECT REPORT** is valid on:

I lines in the ENTRY-SECTION

T lines in the ENTRY-SECTION.

CTnnE lines in the CONTROL-SECTION.

Any command line in the REPORT-SECTION, for example, **DC** and **CBnnC** lines.

INPUT MESSAGE

FUNCTION

This command uses messages from the Dictionary-IV dictionary to prompt for and accept operator input from the terminal.

SYNTAX

```
I101 INPUT MESSAGE msg-code-string INTO Data Name/variable  
:  
: USING "msg-dict-name"  
:  
: msg-code-string  
:  
: type, number [, display-mode [, clear [, (col,ln)  
:  
: [, *1-replacement [, *2-replacement...]]]]]
```

type Use of the following valid values:

- I** Input.
- N** Non-input.
- P** Prompt.
- Y** Yes/No.
- i** Input, prints data from **INTO** *Data Name* or *variable* as default value.
- n** Non-input, no suffix, no carriage return needed.
- x** Non-input, no suffix, carriage return needed.

number the number of a message in the Dictionary-IV dictionary.

display-mode Use one of the following valid values:

- (blank) Standard print mode.
- B** Background.
- C** Clear message area and exit.
- F** Foreground.
- R** Reverse video foreground.
- X** Return message, do not print.
- r** Reverse video background.

clear Use one of the following valid values:

- A** Clear line before and after.
- B** Clear line before.
- C** Clear line after.
- D** Clear message area after.
- E** Clear Screen before and after.
- F** Clear Screen before.
- G** Clear Screen after.
- X** Do not clear.
- (blank) Do not clear.

col,ln the column and line position of the display, where (0,0) specifies the top left of the Screen.

**1-replacement* if the message number is null, this can specify a message. If the message number is not null this contains a string value that is to be placed in a message that contains **1*, **2*, etc.

msg-dict-name the name of an Dictionary-IV defined message dictionary.

Data Name/variable a numeric data name or variable name.

NOTES

- **INPUT MESSAGE** *msg-code-string* **INTO** prints the specified message from the message dictionary and stores operator response in the *Data Name* or *variable* specified by the **INTO** clause.
- All parameters specified with the **INPUT MESSAGE** command override the values defined for the message in the message dictionary.
- The replacement value in the *msg-code-string* can specify a replacement value that is to be placed in a message that contains **1*, **2*, etc.
- In order to perform a replacement, the message must contain a **1*. If the replacement value is **ABCD**, and the message is **File *1 is busy**, then the displayed message will be **File ABCD is busy**. For each substitution there is another **n* entry in the message, where *n* is a positive integer.
- To display a non-dictionary message using the *msg-code-string* options, specify a null message number, any *display-mode*, *clear*, or position options and a **n-replacement* that equals the message you wish to display.
- The **TERM-KEY** variable can be used to specify an input time limit.
- **INPUT MESSAGE** is valid on:

I lines in the ENTRY-SECTION.

T lines in the ENTRY-SECTION.

CTnnE lines in the CONTROL-SECTION.

Any command line in the REPORT-SECTION, for example, **DC** and **CBnnC** lines.

EXAMPLES

```
DN      INPUT-FLAG (1)
I102   INPUT MESSAGE "Y,5" INTO INPUT-FLAG
:      USING "4SSAMPLE"
:      IF INPUT-FLAG = "Y" THEN
:         LET INPUT-FLAG = "T"
:      ELSE
:         IF INPUT-FLAG = "N" THEN
:            LET INPUT-FLAG = ""
```

RUN PUBLIC

FUNCTION

This command executes a public script.

SYNTAX

```
I101  RUN PUBLIC script-name [,value/name [,value/name]. . .]
```

script-name a string data name, variable, constant, or expression that specifies the name of a public script defined in the Dictionary-IV dictionary.

value/name a data name, variable, constant, or expression to be passed into and/or returned from the public script.

NOTES

- **RUN PUBLIC** executes a public script and can pass and receive values.
- If a value or name list is specified for the **RUN PUBLIC** command, there must be a corresponding **ENTER PUBLIC** command in the public script, and the value or name list in both scripts must agree in type.
- When the public script is terminated, execution returns to the report at the command line following the **RUN PUBLIC**.
- **RUN PUBLIC** can be used on:

I lines in the ENTRY-SECTION.

T lines in the ENTRY-SECTION.

CTnnE lines in the CONTROL-SECTION.

DC lines in the REPORT-SECTION.

HC lines in the REPORT-SECTION

FC lines in the REPORT-SECTION.

STnnC lines in the REPORT-SECTION.

CTnnC lines in the REPORT-SECTION.

CBnnC lines in the REPORT-SECTION.

TERM-KEY

FUNCTION

This report variable interacts with the **INPUT MESSAGE** and **CONNECT REPORT** command. **TERM-KEY** returns a numeric value corresponding to the key entered by the operator.

SYNTAX

TERM-KEY

NOTES

- Only termination keys and special keys return a value to **TERM-KEY**. Field edit keys, which are used to perform editing functions in these commands, do not affect the value of **TERM-KEY**.
- In an **INPUT** [*Thoroughbred Basic options*] command, the **TERM-KEY** variable is not used. The value of a function key entered by the operator is returned to the Thoroughbred Basic **CTL** variable.
- **TERM-KEY** can be used to specify the number of seconds to be allowed for an **INPUT MESSAGE**. Prior to anticipated input, set **TERM-KEY** to a negative integer value from **-101** through **-32867**. The specified input time limit equals $(\text{TERM-KEY value} + 100) * (-1)$ seconds. A time-out occurs when the time limit is exceeded. A time-out automatically terminates the input and sets **TERM-KEY** to a value of **-99**.
- Please refer to the following chart for terminal keyboard values.

TERMINAL KEYBOARD VALUES (TERM-KEY)

- E** Field Edit Keys (edit and move within a field)
- T** Termination Keys (terminates input to a field)
- C** Field Control Keys (move between fields)
- S** Special Purpose Keys (performs a fixed function, cannot override)

Value	Special Key	Type (Function)	Value	Special Key	Type (Function)
16	Function Key 16	T	-05	Back Space	E
15	Function Key 15	T	-06	Character Delete	E
14	Function Key 14	T	-07	Character Insert	E
13	Function Key 13	T	-08	Line Insert	T
12	Function Key 12	T	-09	Line Delete	T
11	Function Key 11	T	-10	Line Erase	E
10	Function Key 10	T,C (Goto Field)	-11	Page Erase	T
09	Function Key 09	T	-12	Tab	E
08	Function Key 08	T	-13	Back Tab	E
07	Function Key 07	T	-14	Home	E
06	Function Key 06	S (Help)	-15	Control P	(None)
05	Function Key 05	T	-16	Page Down	T,C (Last Field)
04	Function Key 04	S (End)	-17	Page Up	T,C (First Field)
03	Function Key 03	T	-18	Screen Down	T
02	Function Key 02	T	-19	Screen Up	T
01	Function Key 01	T	-20	Boundary Down	T
00	Return/Enter	T	-21	Boundary Up	T
-01	Right Arrow	E	-22	User Defined	
-02	Left Arrow	E	-99	Input Time-out Occurred	
-03	Down Arrow	T,C (Next Field)	-101	1-Second Input Time Limit	
-04	Up Arrow	T,C (Previous Field)	-32867	(32867-second input time limit)	

EXAMPLES

```
I110 INPUT MESSAGE "I,12" INTO U0$
: USING "UTMSG$"
```

```
I112 IF TERM-KEY = 4 THEN
: GOTO 901
```

OUTPUT TO EXCEL

NOTE: This feature requires Thoroughbred Gateway for Windows.

There are two ways to output to Excel:

- Select EXCEL as the printer device. This capability is only available from Report-IV.
- Write a method that calls Report-IV setting "T" to the output type and also setting entry 6 to the name of the file to be used for the tab-delimited file that Report-IV generates.

Each time Excel is selected for output, a new Excel workbook is created. To change workbooks select the appropriate Microsoft Excel Book in the task bar; or from the Excel menu bar select the Window option and then select the appropriate Book (window).

Setting Up the EXCEL Printer Device

The Thoroughbred Environment includes an EXCEL printer table. From the **System Administration** menu select **Printer Assignment**. For more information see the Dictionary-IV Administrator Guide. Assign any printer device (i.e. RS, LP, P1) to the EXCEL printer table. The recommended printer device is RE. You will then need to modify your IPLINPUT file to include this printer device. For more information see the Thoroughbred Basic Customization and Tuning Guide.

IPLINPUT for Windows Basic:

```
DEV RE,4,,,,,NULL
```

IPLINPUT for UNIX:

```
DEV RE,4,,,1,,,/dev/null
```

Creating a Method

Create a Method to perform the following:

- Create and open a text file.
- Call OOR (CONNECT REPORT) to execute the Report-IV definition directing output to a tabbed export file.

```
OO3A$[1]= name of the Report-IV definition.  
OO3A$[6]= "CH:" + text file channel.  
OO3A$[7]="T" specify output to a tabbed export file.
```

- Call OO3AXPRT to read the text file and send the contents to Excel.

```
OO3A$[1]= "E" specifying output for Excel.  
OO3A$[1]=text_file_name
```

For example:

```
PROCEDURE
WINDOW CREATE (80,24,0,0);
DIM OOR$[10];
CLEAR ERC;
CHP=UNT;
OPEN (CHP) ". "; ! Find
PFX$=FID(CHP), ! directory number
PFX=ASC(PFX$(20,1)); ! of prefix directory
CLOSE (CHP);
OUT$="SendToExcel"; ! export file name
WHILE ERC =0; ! erase
    ERASE OUT$,ERC=12 ! all copies
WEND; ! of the file
CLEAR ERC; ! clear error control
TEXT OUT$, PFX, 0; ! create export file
OPEN (CHP,OPT="TEXT") OUT$; ! open output channel*
OOR$[1]="RRRCUST", ! set report name
OOR$[6]="CH:"+STR(CHP), ! set output to channel
OOR$[7]="T"; ! set Export Tabbed file*
CALL "OOR", OOR$[ALL]; ! execute report
CLOSE (CHP); !
IF OOR$[0]="." ! if good report
    DIM OO3A$[1]; !
    OO3A$[0]="E", ! set excel
    OO3A$[1]=OUT$; ! set export file name
    CALL "OO3AXPRT", OO3A$[ALL] ! send to excel*
FI;
```

REPORT-IV UTILITIES

This section describes Report-IV utilities.

Introduction

This section describes the options from the Thoroughbred Dictionary-IV Supplemental Utilities Menu that apply to Report-IV. The Report-IV software is integrated with Dictionary-IV that allows users to access options from Dictionary-IV menus.

The Thoroughbred Dictionary-IV supplemental utilities covered are:

Convert REPORT to Report-IV

- File Definition (to Format)
- Printer Table
- Report Definition

Miscellaneous

- Thoroughbred Report-IV: Compile Reports
- Thoroughbred Report-IV: Compile Errors

For more information about the Dictionary-IV Supplemental Utilities Menu options, see the Dictionary-IV Administrator Guide.

Convert REPORT File Definition (to Format)

The File Definition to Format Conversion Utility allows you to convert existing Thoroughbred REPORT file definitions into Report-IV definitions maintained in Dictionary-IV. You can convert definitions by library, range, or mask.

Dictionary-IV Supplemental Utilities Menu

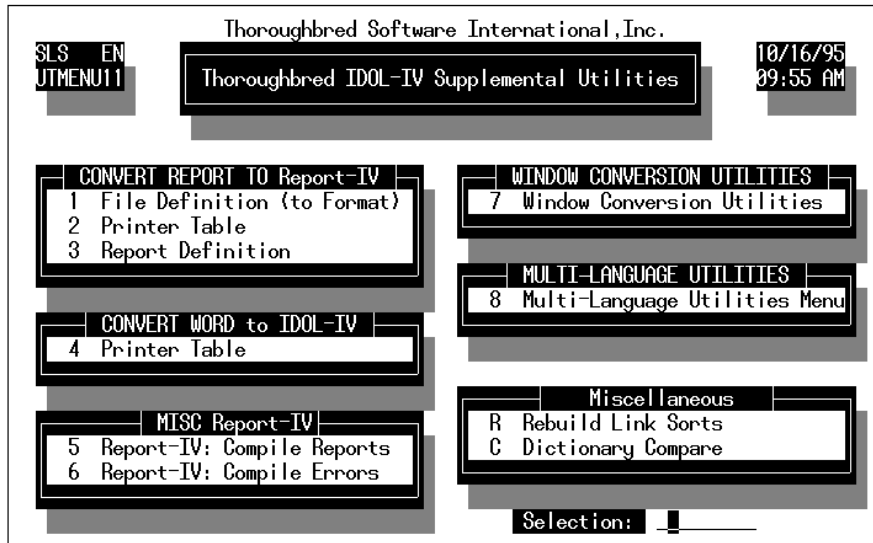

From the Supplemental Utilities Menu, select option **1. File Definition** (to Format). The conversion screen is displayed. The system prompts:

Library:

Enter the two-character library ID of the Thoroughbred REPORT library to convert.

Select everything:

Select one of the following:

Y converts every definition in the library.

N enables you to specify a range of definitions to convert.

If you select **N**, the cursor goes to the prompt:

```
from name .....: (RETURN for first)
to name .....: (RETURN for same or last)
```

Enter the range of definition names. When selecting a range of names, press the **Enter** key twice to select the first and last names in the library.

```
using name mask.....: (RETURN for none)
```

A name mask allows you to select definitions without specifying individual names. If you do not wish to use a mask, bypass this prompt by pressing the **Enter** key.

A mask sets up a matching test. If a definition name matches the mask, then it is selected. If no match is made, it is bypassed. A mask contains match and passing characters. The characters in a Format name must match all of the match characters (same character and position) for it to be selected. The pass character (?) is used to indicate that no match in this position is needed.

Mask	Action	Definition Names
A?	selects bypasses	AB AC A1 aB cA 11

This utility treats everything in the library as a file definition. If the library contains a variety of definitions, you should use the procedure to convert one definition or a range of definitions instead of converting the entire library. Definition types that are categorized as "F" are selected.

Is the displayed information correct?

Select one of the following:

N enables you to make changes.

Y proceeds with the conversion. The system converts the specified definitions. If a definition has already been converted, or if a definition already exists by that name, the system asks if it should replace the existing definition.

XXXXXXXX already exists, replace?

Select one of the following:

Y The system overwrites the existing definition.

N The existing definition is not overwritten and the next definition is read. If an end of definition is reached, the conversion is stopped and the menu is displayed.

To interrupt the conversion process, press the key sequence that represents the **Escape** key. The system asks if you want to terminate; enter the appropriate response.

New Definition Location

Thoroughbred REPORT File Definitions are converted to Dictionary-IV formats and can be accessed by entering the definition name in Format Maintenance.

When accessing the new Dictionary-IV format, if the library that was converted does not exist in Dictionary-IV, the system prompts:

Creating new Library, enter Title:

Enter the library title. The definition is accessible.

Convert REPORT to Report-IV (Printer Table Conversion)

This Printer Table Conversion Utility allows you to convert existing Thoroughbred REPORT printer tables into Report-IV printer tables that are maintained in Dictionary-IV. You can convert printer tables by library, range, or mask.

From the Supplemental Utilities Menu, select option **2. Printer Table**. The conversion screen is displayed and the system prompts:

Library:

Enter the two-character library ID of the Thoroughbred REPORT library to convert.

Select everything:

Y converts every printer table in the library.

N enables you to specify a range of printer tables to convert.

If you select **N**, the cursor goes to the prompt:

from name : (RETURN for first)
to name : (RETURN for same or last)

Enter the range of printer table names. When selecting a range of names, press the **Enter** key twice to select the first and last names in the library.

using name mask : (RETURN for none)

A name mask allows you to select definitions without specifying individual names. If you do not wish to use a mask, bypass this prompt by pressing the **Enter** key.

A mask sets up a matching test. If a definition name matches the mask, then it is selected. If no match is made, it is bypassed. A mask contains match and passing characters. The characters in a Format name must match all of the match characters (same character and position) for it to be selected. The pass character (?) is used to indicate that no match in this position is needed.

Mask	Action	Definition Names
A?	selects	AB AC A1
	bypasses	aB cA 11

Is the displayed information correct?

Select one of the following:

Y proceeds with the conversion.

N enables you to make changes.

The system converts the specified printer tables. If a printer table has already been converted, or if a printer table already exists by that name, the system asks if it should replace the existing definition.

XXXXXXXX already exists, replace?

Select one of the following:

Y The system overwrites the existing definition.

N The existing definition is not overwritten and the next printer table is read. If an end of file is reached, the conversion is stopped and the Development Utilities Menu is displayed.

To exit while the conversion is in process, press the **Escape** key. The system asks if you want to terminate. Enter the appropriate response.

New Printer Table Location

Thoroughbred REPORT printer tables are converted to Dictionary-IV printer tables and can be accessed by using the Printer Maintenance Utility.

Convert REPORT to Report-IV (Report Definition)

The REPORT Definition to Report-IV Conversion Utility allows you to convert existing Thoroughbred REPORT definitions into Report-IV definitions maintained in Dictionary-IV. You can convert definitions by library, range, or mask.

From the Supplemental Utilities Menu, select option **3. Report Definition**. The conversion menu displays and the system prompts:

Library:

Enter the two-character library ID of the Thoroughbred REPORT library to convert.

Select everything:

Select one of the following:

Y converts every report definition in the library.

N enables you to specify a range of report definitions to convert.

If you select **N**, the cursor goes to the prompt:

```
from name...:      (RETURN for first)
to name .....:    (RETURN for same or last)
```

Enter the range of report definition names. When selecting a range of names, press the **Enter** key twice to select the first and last names in the library.

using name mask....: (RETURN for none)

A name mask allows you to select definitions without specifying individual names. If you do not wish to use a mask, bypass this prompt by pressing the Enter key.

A mask sets up a matching test. If a definition name matches the mask, then it is selected. If no match is made, it is bypassed. A mask contains match and passing characters. The characters in a Format name must match all of the match characters (same character and position) for it to be selected. The pass character (?) is used to indicate that no match in this position is needed.

Mask	Action	Definition Names
A?	selects	AB AC A1
	bypasses	aB cA 11

Is the displayed information correct?

Select one of the following:

Y proceeds with the conversion.

N enables you to make changes.

The system converts the specified definitions. If a definition has already been converted, or if a definition already exists by that name, the system asks if it should replace the existing definition.

XXXXXXXX already exists, replace?

Select one of the following:

Y The system overwrites the existing definition.

N The existing definition is not overwritten and the next definition is read. If an end of file is reached, the conversion is stopped.

To interrupt the conversion process, press the **Escape** key. The system asks if you want to terminate. Enter the appropriate response.

New Definition Location

Thoroughbred REPORT definitions are converted to Report-IV reports and can be accessed by entering the report name in Report-IV.

If you try to access REPORT definitions using the Report-IV Definition Maintenance screen and the library that was converted does not exist in Dictionary-IV, the system prompts:

Creating new Library, enter Title:

Enter the library title. The definition is accessible.

Thoroughbred Report-IV (Compile Reports)

Compiling a report is sometimes referred to as phasing, because the compilation goes through phases. Options in this utility allow you to compile all reports or specify a library, a range of reports in a library, and a name mask.

From the Supplemental Utilities Menu, select option **5. Report-IV: Compile Reports**.

The system prompts:

R-REPORT-IV **Q-QUERY** **B-Both**

Select **R** for Report-IV.

The system prompts:

Do you want to compile everything?

Select one of the following:

Y compiles all reports from all libraries.

N enables you to make the following specifications:

If you select **N**, the Compile screen is displayed.

Library:

Enter the two-character library ID for the reports that you want to compile.

Select everything:

Select one of the following:

Y compiles every report in the library.

N enables you to specify a range of reports to compile.

If you select **N**, the cursor goes to the prompt:

from name.....: (RETURN for first)
to name: (RETURN for same or last)

Enter the range of report definition names. When selecting a range of names, press the **Enter** key twice to select the first and last names in the library.

using name mask.....: (RETURN for none)

A name mask allows you to select definitions without specifying individual names. If you do not wish to use a mask, skip this prompt by pressing the **Enter** key.

A mask sets up a matching test. If a definition name matches the mask, then it is selected. If no match is made, it is skipped. A mask contains match and passing characters. The characters in a Format name must match all of the match characters (same character and position) for it to be selected. The pass character (?) is used to indicate that no match in this position is needed.

Mask	Action	Definition Names
A?	selects bypasses	AB AC A1 aB cA 11

Is the displayed information correct?

Select one of the following:

Y compiles the specified reports.

N enables you to make changes.

The system begins the compilation and displays a screen providing information on the current report being compiled and indicating the compile phase.

To interrupt the compilation process, press the **Escape** key.

Do you want to discontinue report?

Select one of the following:

Y skips the current report and continues with the next report.

N resumes compiling the current report.

F4 aborts the compiling process.

Report-IV Compile Errors

This option allows you to view report compile errors. You have the option of printing the compile errors to a selected printer or on the terminal screen.

From the Supplemental Utilities Menu, select option **6. Report-IV: Compile Errors**. A View appears, listing reports that contain errors, and descriptions of those errors.

If no errors are encountered the following message appears:

No phase errors encountered, RETURN to continue.

If errors are encountered, a View appears with errors and associated information. When you press the **F4** key from the View, the system prompts:

Do you want a printed copy?

Select one of the following:

Y You are prompted to select a printer if there is more than one configured and a printed copy will be produced.

N Does not print the compile errors to a printer.

If you select printed output, the system prompts:

Select printer (xx xx): xx

Select the printer; *xx* represents a defined printer name for your system. Press **F1** to display a complete list of available printers.

ERROR MESSAGES

The following is a list of Dictionary-IV system messages specific to Report-IV.

Bad syntax or argument out of range

The syntax is incorrect or invalid.

Cannot determine access to file XXXXXXXXX

Access to the specified file cannot be determined by Report-IV. Access is obtained when a Link between two files is discerned. This is usually made when a Data Name is common to both files or a Data Name in the first file has been defined as the key to the second file.

Cannot determine size of XXXXXXXXX

A data name declared in two or more formats has dissimilar attributes.

Cannot locate Dictionary-IV sort file XXXXXXXXX

The specified SORT file cannot be located.

Cannot locate file XXXXXXXXX

The specified file cannot be located.

Definition Size Limit Reached! Please Save

A report definition cannot exceed 512 lines.

Duplicate Control or Variable Name

Multiple definitions have been found for the above data name. This could be in the ENTRY-SECTION in a DN or FN line, or in the CONTROL-SECTION with **ST**, **CB**, or **CT** line having the same number.

Error Attempting to Include Format *1

The specified Format could not be included. Run the Dictionary Update for a detailed analysis.

Error in File Definition specifications

The file definition contains errors on conditions or specification that cannot be interpreted or resolved.

Error in Field Specification of Data Name

The field specification for a Data Name contains errors on conditions or specifications that cannot be interpreted or resolved.

Formula result overlaps adjacent formula

The result of this formula, as calculated, will overlap an adjacent formula (to the right). In order to resolve this, you will either need to move one or both of the formulas, or use substring position options to limit the length of the result or the formula.

Formula result will not fit on line

The result of this formula, as calculated, will not fit onto the line with the report width currently set. In order to resolve this, you will either need to move the formula, use substring position options to limit the length of the result of the formula, or expand the width of the report.

Formula too long

The length of the formula has exceeded the valid length.

Invalid LINE TYPE or LINE TYPE structure

The line type is not recognized or the structure is invalid.

JOIN BY is not allowed on the primary LINK

JOIN BY is used to establish a relationship where the relationship between links is ambiguous and is not allowed on the primary Link.

Library has not been created yet

The library name that you have entered has not been created yet. Please enter another name or press the **F4** key to exit.

Library is being edited now

This library is currently being changed by another operator. The library will become available when the changes are completed.

Line Number is invalid or out of range

The value specified for a Innn or a Tnnn line is not numeric or is not in the range of 101 to 199 for an Innn line or 901 to 999 for a Tnnn line.

Line type used is invalid/out of sequence

The line type used is not a valid line type or is not valid in this area of the report definition.

Line type used is not valid

The line type used is not a valid line type or is not valid in this area of the report definition.

Line type used may not contain formulas

The line type used may not contain formulas. The only line types that may utilize this function are those within the REPORT-SECTION.

Line Type used not in CONTROL-SECTION

The line type used is not specified in the CONTROL-SECTION of the report. In order for the line (type and number) to appear in the report area, it must first be specified in the control area.

LNS may not be used when SORT BY specified

The SORT BY clause is invalid.

LNK must be the last entry in the FILE-SECTION.

When an LNK entry is used, it must be the last line type in the FILE-SECTION.

LNK or LNS must be the last entry in the FILE-SECTION

A standard Link entry cannot follow either an LNK or LNS.

Maximum number of LN entries exceeded

LN (LN, LNC, LNU, LNK, LNS) entries are limited to a total of twenty.

Module *1 not found

The definition module specified in an INCLUDE does not exist.

Only one KEY RANGE option is allowed

Only one KEY RANGE option can be specified for the file definitions.

Only one LNK or LNS entry may be used

More than one LNK or more than one LNS cannot be used in a Report-IV definition. Use ANDs or ORs with parenthetical grouping to achieve the desired results.

Report already defined

The report name that you have entered already exists. Please enter another name or press the F4 key to exit.

Report contains too many formulas

A report definition cannot exceed 255 formulas.

Report name must be at least 3 characters

Report names can be from 3 through 8 characters long. You must enter at least three characters, because the first two characters are used as a Library name.

Resultant SORT BY expressions exceeds BASIC SORT size

The specified SORT BY expression exceeds 144 characters.

SORT BY data name is not allowed with DATA-FILE IS

SORT BY SORT0 is valid only on the first link in a report.

SORT BY SORT0 is used to allow run time specification of the Dictionary-IV sort to be used by Report-IV. It may only be used with the primary Link used in a report.

"SORT BY" sort key size too large

Sort key too large for File XXXXXXXX

The specified file's sort key has exceeded the valid length.

Syntax Error, F1 to display

A syntax error has been encountered in the formula or in the resolution of the formula, or in the resolution of some component of the report. This error contradicts Report-IV or Thoroughbred Basic syntax requirements. Press the **F1** key to display the compiled statement that is generating the error.

Text may be used only in a formula

The report name you have entered does not exist

Enter another name, press the **F2** key at the name field entry to view existing reports, or press the **F4** key to exit.

The total data size exceeds the maximum allowed

The total length of Data Names to be included cannot exceed the maximum of 32767 allowed by Thoroughbred Basic.

Unable to Generate Executable Report Module

An executable report cannot be generated. Make sure that the report has not duplicate statement labels, duplicate user-defined functions, and that all Format references are valid. This error will occur if a Format name containing lowercase letters is referenced by a Link in the FILE-SECTION and **PRM UPPER** is on.

Unable to sort because corrupt data.

Undefined Data Name (KEY-RANGE)

An undefined Data Name has been encountered in the KEY RANGE option of the file definition.

Unexpected BASIC Compile Error

A syntax error has been encountered in the formula or in the resolution of the formula, or in the resolution of some component of the report during the compile process in Thoroughbred Basic. Press the **F1** key to display the compiled statement that is generating the error that is displayed in the same window.

USING may not be included with Dictionary-IV sort

The **SORT BY USING** rule cannot be included with Dictionary-IV sort.

XXXXXXXX is being edited by another user

The above report definition module is busy and cannot be accessed at this time.

XXXXXXXX not found

The definition *XXXXXXXX* specified in an **INCLUDE** does not exist.

XXXXXXXX Undefined Data Name (SORT BY)

An undefined Data Name has been encountered in the **SORT BY** option of the file definition.

XXXXXXXX is not a valid File Definition

The **LINK** or **FORMAT** specified in the **FN** or **LN** does not exist or the **FORMAT** associated with the **LINK** specified in the **LN** does not exist.

SAMPLE REPORTS

The reports illustrated in this library are from the **UT** library. You can view, print, or edit the associated formats, links, report definitions, and output.

Note: These reports demonstrate various Report-IV features.

The following sample report definitions and sample output are included:

UTXRS001	Sales Rep List
UTXRS002	Sales History by Rep
UTXRC001	Customer List
UTXRCD02	Item Margin List
UTXRCD04	Sales by Item

Report: UTXRS001

Descrp: REPORT-IV Example - Sales Rep List

Page: 1

Create Date: 05/25/91 Last Change Date: 01/30/95

Number lines: 512

Report Width: 80

Date: 01/30/95

```

=====
!   Simple Report to List Sales Rep File

!   Note that the Sales Rep codes are contained in the data file UTCODES
!   which is a multi format file which also contains the Sales Codes UTSALCD.

!   REPORT-IV has automatically generated a

!           KEY RANGE FROM "R" TO "R"

!   to select only the records for the Link UTREP

```

ENTRY-SECTION

FILE-SECTION

LN UTREP

CONTROL-SECTION

REPORT-SECTION

```

H
H LL-RRRRR XXXXXXXXXXXXXXXXXXXXXXXXXXXXXXXXXXXXXXXXXXXX Page: #
> A B
H MM/DD/YY XXXXXXXXXXXXXXXXXXXXXXXXXXXXXXXXXXXXXXXXXXXX HH:MM ??
> C D E
H
H ----- Commission -----
H Code Name Exten %% MTD YTD
H -----
D XXX XXXXXXXXXXXXXXXXXXXXXXXXXXXXXXXXXXXX XXXX ### ###.00- ####.00-
> F G H I J K

```

Formulas:

- A - /R
- B - /I
- C - /D
- D - /r
- E - /T
- F - REP-CODE
- G - REP-NAME
- H - PHONE-EXT
- I - COMMISSION-PERC
- J - MTD-COMMISSION
- K - YTD-COMMISSION

UT-XRS001
01/27/95

Thoroughbred Software International, Inc.
REPORT-IV Example - Sales Rep List

Page: 1
12:46 PM

Code	Name		Exten	----- Commission -----		
				%%	MTD	YTD
001	James Johnson	0000001.DIB	4513	8	147.96	546.05
002	Helen Tyler	00000012.DIB	4511	8	38.77	428.62
003	Mike Walsh	MARK.DIB	4518	5	17.38	235.60
004	Brian Andrews	ROGER.DIB	4503	5	21.00	298.71

Report: UTXRS002

Descrp: REPORT-IV Example - Sales History by Rep

Page: 1

Create Date: 05/25/91 Last Change Date: 10/18/94
Number lines: 139 Report Width: 80

Date: 01/30/95

=====

ENTRY-SECTION

FILE-SECTION

! UTREP is the driver file for this report. Note that the range
! for the mult format file is automatically applied.

! UTCUST is linked to UTREP by REP-CODE which is IDOL-IV SORT2.

! UTSALHSH is linked to UTCUST by CUST-NO which is IDOL-IV SORT2.

! UTSALHSD is linked to UTSALHSH by INVOICE-NUMBER which is part of the
! key. This is a one to many relationship (HEADER & DETAIL) where more
! than one record in UTSALHSD may exist for each record in UTSALHSH,

! UTSALCD is linked to UTSALHSD by SALES-CODE which is the key.
! Note that the preset value 'S' is automatically used when this
! file is accessed.

! In order to be selected correctly the sorts for UTCUST and UTSALHSH
! should be defined with the case sensitive or (C) option.

LN UTREP
LN UTCUST SORT BY SORT2
LN UTSALHSH SORT BY SORT2
LN UTSALHSD
LN UTSALCD

CONTROL-SECTION

! A CONTROL BREAK is used for processing when a condition is first true.
! A CONTROL BREAK will always occur on the first record in a file.

! A COMPUTED BREAK or SUBTOTAL BREAK will occur when a condition is
! no longer true.
! A COMPUTED OR SUBTOTAL BREAK will always occur at end of file.

! In this report, control breaks are used to process:
! 1) a new rep
! 2) a new company
! 3) a new invoice

! Computed breaks are used to process:
! 1) totals for a rep
! 2) totals for a company
! 3) a blank line at the end of on invoice

! Computed totals are used rather than Subtotals because subtotals are
! accumulated for each record read. The STnn line in the report section
! is executed and the subtotals cleared when the condition is true.
! This would mean that the commission and total invoice amount would
! be accumulated for each invoice line item.

! A computed total is only accumulated when the condition is true.
! A computed total is never cleared so a computed break command
! line is necessary to clear them.

Report: UTXRS002

Descrp: REPORT-IV Example - Sales History by Rep

Page: 2

Create Date: 05/25/91 Last Change Date: 10/18/94

Number lines: 139 Report Width: 80

Date: 01/30/95

```

CB01 WHEN REP-CODE      CHANGES
CT01A WHEN INVOICE-NUMBER CHANGES; REP-COMMISSION, NET-SALE-AMOUNT
CT01P WHEN REP-CODE      CHANGES

CB02 WHEN CUST-CODE     CHANGES
CT02A WHEN INVOICE-NUMBER CHANGES; REP-COMMISSION, NET-SALE-AMOUNT
CT02P WHEN CUST-CODE     CHANGES

CB03 WHEN INVOICE-NUMBER CHANGES
CT03P WHEN INVOICE-NUMBER CHANGES

```

REPORT-SECTION

```

! Printer commands are executed when encountered.
! Print lines are printed when they are complete.
! Because of this, printer commands are in effect for an entire line
! and cannot be used in a single formula within a line.

```

```

H
H LL-RRRRR      XXXXXXXXXXXXXXXXXXXXXXXXXXXXXXXXXXXX      Page: #
> A            B
H MM/DD/YY      XXXXXXXXXXXXXXXXXXXXXXXXXXXXXXXXXXXX      HH:MM ??
> C            D            E
H
H Sales Rep: XXXXXXXXXXXXXXXXXXXXXXXXXXXXXXXX      MTD Commission: ####.00-
> F            G
HC /PC=ULON
H YTD Commission: #####.00-
> H
HC /PC=ULOFF
CB01C /EJECT

CB02C /EJECT4
CB02
CB02 Company: XXXX XXXXXXXXXXXXXXXXXXXXXXXXXXXXXXXX      Current AR: #####.00-
> I J            K
CB02C /PC=ULON
CB02 YTD Sales: #####.00
> L
CB02C /PC=ULOFF
CB02

CB03C /EJECT4
CB03C /PC=ULON
CB03 Invoice: XXXXXX MM/DD/YY      Commission: ####.00 Total: #####.00
> M N            O P
CB03C /PC=ULOFF
CB03
D XXXXXXXXXX XXXXXXXXXXXXXXXXXXXXXXXXXXXXXXXX ##### #####.00 #####.00
> Q R            S T U
CT03

CT02C /EJECT3
CT02C /PC=ULON

```

Report: UTXRS002

Descrp: REPORT-IV Example - Sales History by Rep

Page: 3

Create Date: 05/25/91 Last Change Date: 10/18/94

Number lines: 139

Report Width: 80

Date: 01/30/95

=====
CT02 XXXXXXXXXXXXXXXXXXXXXXXXXXXX Total Comission:#####.00 Total Sales:#####.00

> V W X

CT02C /PC=ULOFF

CT02C CT02(0)=0, CT02(1)=0, CT02(2)=0

CT01C /EJECT3

CT01C /PC=ULON

CT01

CT01 XXXXXXXXXXXXXXXXXXXXXXXXXXXX Total Comission:#####.00 Total Sales:#####.00

> Y Z a

CT01C /PC=ULOFF

CT01C CT01(0)=0, CT01(1)=0, CT01(2)=0

Formulas:

- A - /R
- B - /I
- C - /D
- D - /r
- E - /T
- F - REP-NAME
- G - MTD-COMMISSION
- H - YTD-COMMISSION
- I - CUST-CODE
- J - CUST-NAME
- K - OPEN-AR-BALANCE
- L - YTD-SALES
- M - INVOICE-NUMBER
- N - INVOICE-DATE
- O - REP-COMMISSION
- P - NET-SALE-AMOUNT
- Q - SALES-CODE
- R - SALES-DESCRIPTION(1,32)
- S - QUANTITY
- T - EXTENDED-COST
- U - EXTENDED-PRICE
- V - CUST-NAME
- W - CT02(1):"#####.00"
- X - CT02(2):"#####.00"
- Y - REP-NAME
- Z - CT01(1):"#####.00"
- a - CT01(2):"#####.00"

UT-XRS002
01/27/95

Thoroughbred Software International, Inc.
REPORT-IV Example - Sales History by Rep

Page: 1
12:46 PM

Sales Rep: James Johnson 0000001.DIB MTD Commission: 147.96
YTD Commission: 546.05

Company: 0002 Lakewood Little League Current AR: 822.50
YTD Sales: 2388.50

Invoice: B00104 01/15/91 Commission: 27.67 Total: 553.40

BASEBALLS	Little League Baseballs (DozAPPT	2	37.90	59.90	
CAPS	Baseball Caps	MICR	15	90.00	194.25
SHIRTS	Team T-Shirts	ANSW	15	135.00	299.25

Invoice: B00115 02/14/91 Commission: 8.29 Total: 165.85

BASEBALLS	Little League Baseballs (DozAPPT	2	37.90	59.90	
CATCHER	Catchers Equipment	SATE	1	74.95	105.95

Invoice: B00119 02/23/91 Commission: 50.63 Total: 1012.60

BASEBALLS	Little League Baseballs (DozAPPT	2	37.90	59.90	
CAPS	Baseball Caps	MICR	15	90.00	194.25
BAT31	31" Aluminum Bat	ISIJ	3	42.00	94.50
BAT29	29" Aluminum Bat	COMP	4	54.00	114.00
BAT31	31" Aluminum Bat	ISIJ	3	42.00	94.50
CATCHER	Catchers Equipment	SATE	1	74.95	105.95
MITTR	Right Hand Fielders Mitt	POUN	10	210.00	349.50

Invoice: B00136 03/24/91 Commission: 15.73 Total: 314.55

MITTL	Left Handed Fielders Mitt	PAYP	2	44.00	69.90
MITTR	Right Hand Fielders Mitt	POUN	7	147.00	244.65

Invoice: B00147 04/18/91 Commission: 27.37 Total: 342.10

CAPS	Baseball Caps	MICR	15	90.00	194.25
MITTR	Right Hand Fielders Mitt	POUN	3	63.00	104.85
BASES	Set of 4 Bases	CHEC	1	29.00	43.00

Lakewood Little League Total Commission: 129.69 Total Sales: 2388.50

Company: 0005 Team Sports Current AR: 664.05
YTD Sales: 2831.65

Invoice: B00101 01/05/91 Commission: 56.02 Total: 700.25

BAT29	29" Aluminum Bat	COMP	3	40.50	85.50
MITTR	Right Hand Fielders Mitt	POUN	9	189.00	314.55
CAPS	Baseball Caps	MICR	15	90.00	194.25
CATCHER	Catchers Equipment	SATE	1	74.95	105.95

Invoice: B00112 02/05/91 Commission: 13.27 Total: 165.85

BASEBALLS	Little League Baseballs (DozAPPT	2	37.90	59.90	
CATCHER	Catchers Equipment	SATE	1	74.95	105.95

UT-XRS002
01/27/95

Thoroughbred Software International, Inc.
REPORT-IV Example - Sales History by Rep

Page: 2
12:46 PM

Sales Rep: James Johnson 0000001.DIB MTD Commission: 147.96

YTD Commission: 546.05

Invoice: B00122 02/27/91 Commission: 22.79 Total: 284.85

BAT30	30" Aluminum Bat	COPY	4	54.00	114.00
CATCHER	Catchers Equipment	SATE	1	74.95	105.95
MITTL	Left Handed Fielders Mitt	PAYP	1	22.00	34.95
BASEBALLS	Little League Baseballs (DozAPPT		1	18.95	29.95

Invoice: B00131 03/14/91 Commission: 32.33 Total: 404.10

SHIRTS	Team T-Shirts	ANSW	15	135.00	299.25
MITTL	Left Handed Fielders Mitt	PAYP	3	66.00	104.85

Invoice: B00133 03/16/91 Commission: 30.63 Total: 612.55

BAT31	31" Aluminum Bat	ISIJ	1	14.00	31.50
CATCHER	Catchers Equipment	SATE	1	74.95	105.95
MITTR	Right Hand Fielders Mitt	POUN	2	42.00	69.90
SHIRTS	Team T-Shirts	ANSW	15	135.00	299.25
CATCHER	Catchers Equipment	SATE	1	74.95	105.95

Invoice: B00144 04/13/91 Commission: 53.12 Total: 664.05

MITTL	Left Handed Fielders Mitt	PAYP	9	198.00	314.55
MITTR	Right Hand Fielders Mitt	POUN	10	210.00	349.50

Team Sports Total Commisison: 208.16 Total Sales: 2831.65

Company: 0007 Dayton Little Devils Baseball Current AR: 503.70
YTD Sales: 1259.25

Invoice: B00117 02/19/91 Commission: 22.41 Total: 448.20

BAT30	30" Aluminum Bat	COPY	4	54.00	114.00
MITTR	Right Hand Fielders Mitt	POUN	1	21.00	34.95
SHIRTS	Team T-Shirts	ANSW	15	135.00	299.25

Invoice: B00128 03/08/91 Commission: 64.88 Total: 811.05

CAPS	Baseball Caps	MICR	15	90.00	194.25
MITTR	Right Hand Fielders Mitt	POUN	3	63.00	104.85
BASES	Set of 4 Bases	CHEC	1	29.00	43.00
BAT31	31" Aluminum Bat	ISIJ	3	42.00	94.50
MITTR	Right Hand Fielders Mitt	POUN	9	189.00	314.55
BASEBALLS	Little League Baseballs (DozAPPT		2	37.90	59.90

Dayton Little Devils Baseball Total Commisison: 87.29 Total Sales: 1259.25

Company: 0012 Hackensack Hackers Current AR: 825.21
YTD Sales: 1729.10

Invoice: B00105 01/18/91 Commission: 13.43 Total: 167.85

MITTL	Left Handed Fielders Mitt	PAYP	3	66.00	104.85
BAT31	31" Aluminum Bat	ISIJ	2	28.00	63.00

UT-XRS002
01/27/95

Thoroughbred Software International, Inc.
REPORT-IV Example - Sales History by Rep

Page: 3
12:46 PM

Sales Rep: James Johnson 0000001.DIB MTD Commission: 147.96
YTD Commission: 546.05

Invoice: B00118 02/21/91 Commission: 52.53 Total: 656.65

MITTL	Left Handed Fielders Mitt	PAYP	3	66.00	104.85
CAPS	Baseball Caps	MICR	15	90.00	194.25
BASES	Set of 4 Bases	CHEC	1	29.00	43.00
MITTR	Right Hand Fielders Mitt	POUN	9	189.00	314.55

Invoice: B00121 02/27/91 Commission: 25.50 Total: 509.90

CAPS	Baseball Caps	MICR	15	90.00	194.25
CATCHER	Catchers Equipment	SATE	1	74.95	105.95
MITTL	Left Handed Fielders Mitt	PAYP	2	44.00	69.90
MITTR	Right Hand Fielders Mitt	POUN	3	63.00	104.85
MITTL	Left Handed Fielders Mitt	PAYP	1	22.00	34.95

Invoice: B00137 03/24/91 Commission: 31.58 Total: 394.70

MITTL	Left Handed Fielders Mitt	PAYP	5	110.00	174.75
BAT30	30" Aluminum Bat	COPY	4	54.00	114.00
CATCHER	Catchers Equipment	SATE	1	74.95	105.95

Hackensack Hackers Total Commisison: 123.04 Total Sales: 1729.10

James Johnson 0000001.DIB Total Commisison: 548.18 Total Sales: 8208.50

```

! This Report is a simple Customer List using SORTO.

! SORTO allows the a report to be accessed by any defined IDOL-IV sort.

! This by is done by setting the desired sort number in X$(49,2) prior to
! executing the report from a SCRIPT or a basic program. The ability to
! set the sort number in the ENTRY section is available beginning with
! release 8.3.

! See HELP for FORMAT UTAUTO for a full explanation of the fields in X$

```

ENTRY-SECTION

```
DN SORT-NUMBER(4.0) SORT-DESCRIPTION(40) P-ZIP(10)
```

```

I110 IF X$(40,8) = PAD("ID",8) THEN
: INPUT MESSAGE "I,6" INTO SORT-NUMBER USING "UTEXAMPS";
: IF TERM-KEY = 4 THEN
: GOTO 901
: ELSE
: IF SORT-NUMBER >= 0 AND SORT-NUMBER <= 5 THEN
: X$(49,2) = STR( SORT-NUMBER )
: ELSE
: GOTO 110
: FI
: FI;
: M9$ = "P," + STR( 6 + SORT-NUMBER ) + ",X";
: INPUT MESSAGE M9$ INTO SORT-DESCRIPTION USING "UTEXAMPS"

```

FILE-SECTION

```
LN UTCUST SORT BY SORTO
```

CONTROL-SECTION

```

ST00 WHEN SORT-NUMBER = 0 AND CUST-CODE CHANGES ; OPEN-AR-BALANCE, YTD-SALES
ST01 WHEN SORT-NUMBER = 1 AND CUST-NAME CHANGES ; OPEN-AR-BALANCE, YTD-SALES
ST02 WHEN SORT-NUMBER = 2 AND REP-CODE CHANGES ; OPEN-AR-BALANCE, YTD-SALES
ST03 WHEN SORT-NUMBER = 3 AND STATE CHANGES ; OPEN-AR-BALANCE, YTD-SALES
ST04 WHEN SORT-NUMBER = 4 AND ZIP-CODE CHANGES ; OPEN-AR-BALANCE, YTD-SALES

```

```

CTOOP WHEN (SORT-NUMBER = 0 AND CUST-CODE CHANGES) OR
: (SORT-NUMBER = 1 AND CUST-NAME CHANGES) OR
: (SORT-NUMBER = 2 AND REP-CODE CHANGES) OR
: (SORT-NUMBER = 3 AND STATE CHANGES) OR
: (SORT-NUMBER = 4 AND ZIP-CODE CHANGES)

```

REPORT-SECTION

```

H
H LL-RRRRR XXXXXXXXXXXXXXXXXXXXXXXXXXXXXXXXXXXX Page: #
> A B
H MM/DD/YY XXXXXXXXXXXXXXXXXXXXXXXXXXXXXXXXXXXX HH:MM ??
> C D E
H XXXXXXXXXXXXXXXXXXXXXXXXXXXXXXXXXXXX
> F
H

```

Report: UTXRC001

Descrp: REPORT-IV Example - Customer List

Page: 2

Create Date: 05/24/91 Last Change Date:

Number lines: 512 Report Width: 80

Date: 01/30/95

```

=====
H          Sales      Credit
H  Code Name, Phone & Address      Rep      Limit   Open AR   YTD Sales
H  -----
DC  /EJECT3
D  XXXX XXXXXXXXXXXXXXXXXXXXXXXXXXXX XXX      #####  #####.00-  #####.00
>   G  H          I          J          K          L
D?   XXX XXX-XXXX XXXXXXXXXXXXXXXXXXXX XXXXXXXXXXXXXXXXXXXX XX XXXXXXXXXX
>H   N          O
D/O  XXXXXXXXXXXXXXXXXXXXXXXXXXXXXXXXXXXXXXXXXXXXXXXXXXXXXXXXXXXX
>   P
D
CT00
ST00          #####.00-  #####.00
>   Q          R
ST01          #####.00-  #####.00
>   S          T
ST02          #####.00-  #####.00
>   U          V
ST03          #####.00-  #####.00
>   W          X
ST04          #####.00-  #####.00
>   Y          Z
CT00

```

Formulas:

```

A - /R
B - /I
C - /D
D - /r
E - /T
F - SORT-DESCRIPTION(/CTR)
G - CUST-CODE
H - CUST-NAME
I - REP-CODE
J - CREDIT-LIMIT
K - OPEN-AR-BALANCE
L - YTD-SALES
M - IF LEN(ZIP-CODE(/OTS)) = 9
    P-ZIP = ZIP-CODE(1,5) + "-" + ZIP-CODE(6)
    ELSE
    P-ZIP = ZIP-CODE
N - PHONE
O - /FIELD(56) = ADDRESS(/OTS) + " " +
    CITY(/OTS) + " " +
    STATE + " " +
    P-ZIP
P - CREDIT-COMMENTS
Q - ST00(1):"#####.00-"
R - ST00(2):"#####.00"
S - ST01(1):"#####.00-"
T - ST01(2):"#####.00"
U - ST02(1):"#####.00-"
V - ST02(2):"#####.00"
W - ST03(1):"#####.00-"

```

Report: UTXRC001

Descrp: REPORT-IV Example - Customer List

Page: 3

Create Date: 05/24/91 Last Change Date:

Number lines: 512

Report Width: 80

Date: 01/30/95

=====

X - ST03(2):"#####.00"

Y - ST04(1):"#####.00-"

Z - ST04(2):"#####.00"

UT-XRC001
01/27/95

Thoroughbred Software International, Inc.
REPORT-IV Example - Customer List
Listed by Customer Number

Page: 1
12:45 PM

Code	Name, Phone & Address	Sales Rep	Credit Limit	Open AR	YTD Sales
0001	Warren Baseball Club 203 774-2415 1500 Boulevard Rd Warren Baseball Club:	003	1000	.00	1618.55
	Warren Township Little League Ages 10 thru 12 League consist of 8 teams with approx 11 to 13 players Need to contact at the end of the season to cover more teams next year.				
				.00	1618.55
0002	Lakewood Little League 516 934-0221 40 North Main Street Lakewood Little League	001	1000	822.50	2388.50
	* went to Little League World Series in mid 80's Team colors are navy blue and gray. Players ages range from 10 to 12.				
				822.50	2388.50
0003	Southside Raiders 201 345-3240 100 Locust Ave Southside Raiders	004	1000	412.78	1153.65
	Part of Rochelle Park Little League Team colors are yellow and green (Oakland A's).				
				412.78	1153.65
0004	Blue Diamond Baseball 718 230-2424 91 Bayway Ave Blue Diamond Baseball	002	1000	1105.52	1980.50
	All Star team from Brooklyn. Babe Ruth league / summer tournaments.				
				1105.52	1980.50
0005	Team Sports 212 423-4555 503 Glenview Dr Team Sports	001	1000	664.05	2831.65
	Sponsors a team in the T-Ball league in Queens. Players ages 6 and 7.				

UT-XRC001
01/27/95

Thoroughbred Software International, Inc.
REPORT-IV Example - Customer List
Listed by Customer Number

Page: 2
12:45 PM

Code Name, Phone & Address	Sales Rep	Credit Limit	Open AR	YTD Sales
			664.05	2831.65
0006 Westfield Recreation 908 232-1500 100 East Broad St Westfield Recreation	004	1000	525.97	2785.80
0000004.DIB NJ 07090				
Westfield Recreation				
Handles leagues for all ages (7 thru 16).				
We only supply to the International League (ages 10 - 12).				
			525.97	2785.80
0007 Dayton Little Devils Baseball 908 433-4300 725 Austin St Dayton Little League	001	1000	503.70	1259.25
0000001.DIB NJ 07082				
Dayton Little League				
Play in the Union County League.				
Ages 11, 12.				
Team Colors Royal Blue and Orange.				
			503.70	1259.25
0008 Hartford Recreation Office 203 340-3434 100 Route 66 Hartford Recreation	003	1000	1088.25	2353.90
0000003.DIB CT 10081				
Hartford Recreation				
Handles all city leagues				
Need to send literature with our full product line.				
			1088.25	2353.90
0009 Paramus Little League 201 236-4001 750 Walsh Lane Paramus Little League	003	1000	291.30	1717.00
0000003.DIB NJ 07231				
Paramus Little League				
Children ages 9 thru 12				
Township has 8 teams that we supply equipment and uniforms.				
			291.30	1717.00
0010 Fords Little League All Stars 908 345-9292 1967 North Clark St Fords Little League	002	1000	347.55	505.85
0000002.DIB NJ 07034				
Fords Little League				

UT-XRC001
01/27/95

Thoroughbred Software International, Inc.
REPORT-IV Example - Customer List
Listed by Customer Number

Page: 3
12:45 PM

Code Name, Phone & Address	Sales Rep	Credit Limit	Open AR	YTD Sales

Host for summer All Star tournaments.				
			347.55	505.85
0011 Princeton Amateur League 609 359-9090 440 Nassau Street Men's Softball League 40 and over sponsored by the Recreation Dept.	004	1000	687.95	2545.20
			687.95	2545.20
0012 Hackensack Hackers 201 452-3544 191 Lincoln Drive Hackers: Mens Semi Pro Team Greater Tri-State Area Champs last year. Ship COD.	001	1000	825.21	1729.10
			825.21	1729.10
			.00	.00
			.00	.00

Report: UTXRCD02

Descrp: REPORT-IV Example - Item Margin List

Page: 1

Create Date: 05/27/91 Last Change Date:

Number lines: 35

Report Width: 80

Date: 01/30/95

ENTRY-SECTION

I101 PRECISION 4

FILE-SECTION

LN UTSALCD SORT BY (BASE-PRICE - ACCTG-COST) / BASE-PRICE * 100

CONTROL-SECTION

CT01M WHEN SALES-CODE CHANGES; ((BASE-PRICE - ACCTG-COST) / BASE-PRICE * 100)

CT01P WHEN EOF

REPORT-SECTION

H

H LL-RRRRR XXXXXXXXXXXXXXXXXXXXXXXXXXXXXXXXXXXX Page: #

> A B

H MM/DD/YY XXXXXXXXXXXXXXXXXXXXXXXXXXXXXXXXXXXX HH:MM ??

> C D E

H

H Code Description Cost Price Margin

H -----

D XXXXXXXX XXXXXXXXXXXXXXXXXXXXXXXXXXXXXXXXXXXX #####.00 #####.00 ###.00%

> F G H I J

CT01 -----

CT01 Average: ###.00%

> K

CT01 Minimum: ###.00%

> L

CT01 Maximum: ###.00%

> M

Formulas:

A - /R

B - /I

C - /D

D - /r

E - /T

F - SALES-CODE

G - SALES-DESCRIPTION

H - ACCTG-COST

I - BASE-PRICE

J - (BASE-PRICE - ACCTG-COST) / BASE-PRICE * 100
:"###.00%"

K - CT01(2):"###.00%"

L - CT01(3):"###.00%"

M - CT01(4):"###.00%"

UT-XRCD02
01/27/95

Thoroughbred Software International, Inc.
REPORT-IV Example - Item Margin List

Page: 1
12:45 PM

Code	Description		Cost	Price	Margin
CATCHER	Catchers Equipment	SATEDISH.WMF	74.95	105.95	29.26%
BASES	Set of 4 Bases	CHECK.WMF	29.00	43.00	32.56%
BASEBALLS	Little League Baseballs (Doz)	APPTBOOK.WMF	18.95	29.95	36.73%
MITTL	Left Handed Fielders Mitt	PAYPHONE.WMF	22.00	34.95	37.05%
MITTR	Right Hand Fielders Mitt	POUNDBAG.WMF	21.00	34.95	39.91%
BAT29	29" Aluminum Bat	COMPUTER.WMF	13.50	28.50	52.63%
BAT30	30" Aluminum Bat	COPYMACH.WMF	13.50	28.50	52.63%
CAPS	Baseball Caps	MICROCHIP.WM	6.00	12.95	53.67%
SHIRTS	Team T-Shirts	ANSWMACH.WMF	9.00	19.95	54.89%
BAT31	31" Aluminum Bat	ISIJET.WMF	14.00	31.50	55.56%
				Average:	44.49%
				Minimum:	29.26%
				Maximum:	55.56%

ENTRY-SECTION
 I101 PRECISION 4

FILE-SECTION
 LN UTSALCD SORT BY ((BASE-PRICE - ACCTG-COST) / BASE-PRICE * 100) (D)
 LN UTSALHSD SORT BY SORT1
 LN UTSALHSH
 LN UTCUST

CONTROL-SECTION
 CB01 WHEN SALES-CODE CHANGES
 ST01 WHEN SALES-CODE CHANGES; QUANTITY, EXTENDED-COST, EXTENDED-PRICE

REPORT-SECTION

H
 H LL-RRRRR XXXXXXXXXXXXXXXXXXXXXXXXXXXXXXXXXXXX Page: #
 > A B
 H MM/DD/YY XXXXXXXXXXXXXXXXXXXXXXXXXXXXXXXXXXXX HH:MM ??
 > C D E
 H
 H XXXXXXXX XXXXXXXXXXXXXXXXXXXXXXXXXXXXXXXXXXXX
 > F G
 H
 H MTD YTD
 H
 H Units: #####.00
 > H I
 H Sales Price: #####.00 #####.00 #####.00
 > J K L
 H Actual Cost: #####.00 #####.00 #####.00
 > M N O
 H Margin: ###.00% #####.00 #####.00
 > P Q R
 H
 H Invoice Date Customer Quantity Cost Price
 H
 CB01C /EJECT
 D XXXXXX MM/DD/YY XXXXXXXXXXXXXXXXXXXXXXXXXXXX #####.00 #####.00
 > S T U V W X
 ST01
 ST01 #####.00 #####.00
 > Y Z a

Formulas:

- A - /R
- B - /I
- C - /D
- D - /r
- E - /T
- F - SALES-CODE
- G - SALES-DESCRIPTION
- H - UNITS-MTD-YTD(1)
- I - UNITS-MTD-YTD(2)
- J - BASE-PRICE
- K - REVENUE-MTD-YTD(1)

Report: UTXRCD04

Descrp: REPORT-IV Example - Sales by Item

Page: 2

Create Date: 05/27/91 Last Change Date: 09/14/94

Number lines: 32

Report Width: 80

Date: 01/30/95

```
=====
L - REVENUE-MTD-YTD(2)
M - ACCTG-COST
N - COST-MTD-YTD(1)
O - COST-MTD-YTD(2)
P - (BASE-PRICE - ACCTG-COST) / BASE-PRICE * 100
   : "###.00%"
Q - REVENUE-MTD-YTD(1) - COST-MTD-YTD(1)
   : "#####.00"
R - REVENUE-MTD-YTD(2) - COST-MTD-YTD(2)
   : "#####.00"
S - INVOICE-NUMBER
T - INVOICE-DATE
U - CUST-NAME
V - QUANTITY
W - EXTENDED-COST
X - EXTENDED-PRICE
Y - ST01(1) : "#####"
Z - ST01(2) : "#####.00"
a - ST01(3) : "#####.00"
```

UT-XRCD04
01/27/95

Thoroughbred Software International, Inc.
REPORT-IV Example - Sales by Item

Page: 1
12:46 PM

BAT31 31" Aluminum Bat ISIJET.WMF

		MTD	YTD
	Units:	13	59
	Sales Price:	31.50	409.50
	Actual Cost:	14.00	182.00
	Margin:	55.56%	227.50
			1032.50

Invoice Date	Customer	Quantity	Cost	Price
B00105	01/18/91 Hackensack Hackers	2	28.00	63.00
B00108	01/24/91 Paramus Little League	1	14.00	31.50
B00110	02/01/91 Princeton Amateur League	2	28.00	63.00
B00111	02/02/91 Blue Diamond Baseball	3	42.00	94.50
B00114	02/08/91 Hartford Recreation Office	3	42.00	94.50
B00116	02/15/91 Southside Raiders	2	28.00	63.00
B00116	02/15/91 Southside Raiders	3	42.00	94.50
B00119	02/23/91 Lakewood Little League	3	42.00	94.50
B00119	02/23/91 Lakewood Little League	3	42.00	94.50
B00124	03/02/91 Blue Diamond Baseball	3	42.00	94.50
B00125	03/04/91 Paramus Little League	3	42.00	94.50
B00126	03/05/91 Hartford Recreation Office	3	42.00	94.50
B00127	03/05/91 Westfield Recreation	3	42.00	94.50
B00128	03/08/91 Dayton Little Devils Baseball	3	42.00	94.50
B00129	03/10/91 Southside Raiders	3	42.00	94.50
B00130	03/14/91 Warren Baseball Club	3	42.00	94.50
B00132	03/15/91 Warren Baseball Club	2	28.00	63.00
B00133	03/16/91 Team Sports	1	14.00	31.50
B00140	04/05/91 Paramus Little League	3	42.00	94.50
B00142	04/07/91 Princeton Amateur League	1	14.00	31.50
B00143	04/11/91 Blue Diamond Baseball	3	42.00	94.50
B00145	04/15/91 Westfield Recreation	3	42.00	94.50
B00148	04/19/91 Southside Raiders	3	42.00	94.50
		59	826.00	1858.50

UT-XRCD04
01/27/95

Thoroughbred Software International, Inc.
REPORT-IV Example - Sales by Item

Page: 2
12:46 PM

SHIRTS		Team T-Shirts	ANSWMACH.WMF		MTD	YTD		
Invoice Date	Customer	Quantity	Cost	Price				
					Units:	15	150	
					Sales Price:	19.95	299.25	2992.50
					Actual Cost:	9.00	135.00	1350.00
					Margin:	54.89%	164.25	1642.50
B00104	01/15/91 Lakewood Little League	15	135.00	299.25				
B00108	01/24/91 Paramus Little League	15	135.00	299.25				
B00117	02/19/91 Dayton Little Devils Baseball	15	135.00	299.25				
B00120	02/25/91 Princeton Amateur League	15	135.00	299.25				
B00123	02/28/91 Blue Diamond Baseball	15	135.00	299.25				
B00125	03/04/91 Paramus Little League	15	135.00	299.25				
B00131	03/14/91 Team Sports	15	135.00	299.25				
B00133	03/16/91 Team Sports	15	135.00	299.25				
B00139	03/30/91 Hartford Recreation Office	15	135.00	299.25				
B00142	04/07/91 Princeton Amateur League	15	135.00	299.25				
		150	1350.00	2992.50				

UT-XRCD04
01/27/95

Thoroughbred Software International, Inc.
REPORT-IV Example - Sales by Item

Page: 3
12:46 PM

CAPS		Baseball Caps		MICROCHIP.WM		MTD	YTD
Invoice Date	Customer	Quantity	Cost	Price			
					Units:	30	285
					Sales Price:	12.95	388.50
					Actual Cost:	6.00	180.00
					Margin:	53.67%	208.50
							1980.75
B00100	01/05/91 Warren Baseball Club	15	90.00	194.25			
B00101	01/05/91 Team Sports	15	90.00	194.25			
B00104	01/15/91 Lakewood Little League	15	90.00	194.25			
B00113	02/06/91 Westfield Recreation	15	90.00	194.25			
B00113	02/06/91 Westfield Recreation	15	90.00	194.25			
B00118	02/21/91 Hackensack Hackers	15	90.00	194.25			
B00119	02/23/91 Lakewood Little League	15	90.00	194.25			
B00120	02/25/91 Princeton Amateur League	15	90.00	194.25			
B00121	02/27/91 Hackensack Hackers	15	90.00	194.25			
B00123	02/28/91 Blue Diamond Baseball	15	90.00	194.25			
B00127	03/05/91 Westfield Recreation	15	90.00	194.25			
B00128	03/08/91 Dayton Little Devils Baseball	15	90.00	194.25			
B00132	03/15/91 Warren Baseball Club	15	90.00	194.25			
B00132	03/15/91 Warren Baseball Club	15	90.00	194.25			
B00134	03/18/91 Westfield Recreation	15	90.00	194.25			
B00135	03/21/91 Princeton Amateur League	15	90.00	194.25			
B00139	03/30/91 Hartford Recreation Office	15	90.00	194.25			
B00146	04/18/91 Hartford Recreation Office	15	90.00	194.25			
B00147	04/18/91 Lakewood Little League	15	90.00	194.25			
		285	1710.00	3690.75			

UT-XRCD04
01/27/95

Thoroughbred Software International, Inc.
REPORT-IV Example - Sales by Item

Page: 4
12:46 PM

BAT29		29" Aluminum Bat		COMPUTER.WMF		MTD	YTD
						-----	-----
		Units:				4	30
		Sales Price:		28.50		114.00	855.00
		Actual Cost:		13.50		54.00	405.00
		Margin:		52.63%		60.00	450.00
Invoice Date	Customer	Quantity	Cost	Price			

B00101	01/05/91 Team Sports	3	40.50	85.50			
B00106	01/19/91 Blue Diamond Baseball	4	54.00	114.00			
B00109	01/29/91 Fords Little League All Stars	1	13.50	28.50			
B00119	02/23/91 Lakewood Little League	4	54.00	114.00			
B00120	02/25/91 Princeton Amateur League	3	40.50	85.50			
B00125	03/04/91 Paramus Little League	4	54.00	114.00			
B00126	03/05/91 Hartford Recreation Office	2	27.00	57.00			
B00132	03/15/91 Warren Baseball Club	3	40.50	85.50			
B00134	03/18/91 Westfield Recreation	2	27.00	57.00			
B00140	04/05/91 Paramus Little League	2	27.00	57.00			
B00142	04/07/91 Princeton Amateur League	2	27.00	57.00			
						-----	-----
						30	405.00 855.00

UT-XRCD04
01/27/95

Thoroughbred Software International, Inc.
REPORT-IV Example - Sales by Item

Page: 5
12:46 PM

BAT30		30" Aluminum Bat		COPYMACH.WMF		MTD	YTD
						-----	-----
		Units:					28
		Sales Price:		28.50		.00	798.00
		Actual Cost:		13.50		.00	378.00
		Margin:		52.63%		.00	420.00
Invoice Date	Customer	Quantity	Cost	Price			

B00100	01/05/91 Warren Baseball Club	3	40.50	85.50			
B00103	01/12/91 Princeton Amateur League	4	54.00	114.00			
B00117	02/19/91 Dayton Little Devils Baseball	4	54.00	114.00			
B00120	02/25/91 Princeton Amateur League	3	40.50	85.50			
B00122	02/27/91 Team Sports	4	54.00	114.00			
B00130	03/14/91 Warren Baseball Club	4	54.00	114.00			
B00134	03/18/91 Westfield Recreation	2	27.00	57.00			
B00137	03/24/91 Hackensack Hackers	4	54.00	114.00			
						-----	-----
						28	378.00 798.00

UT-XRCD04
01/27/95

Thoroughbred Software International, Inc.
REPORT-IV Example - Sales by Item

Page: 6
12:46 PM

MITTR Right Hand Fielders Mitt POUNDBAG.WMF

		MTD	YTD
Units:		24	159
Sales Price:	34.95	838.80	5557.05
Actual Cost:	21.00	504.00	3339.00
Margin:	39.91%	334.80	2218.05

Invoice Date	Customer	Quantity	Cost	Price
B00101	01/05/91 Team Sports	9	189.00	314.55
B00102	01/06/91 Westfield Recreation	9	189.00	314.55
B00106	01/19/91 Blue Diamond Baseball	3	63.00	104.85
B00108	01/24/91 Paramus Little League	4	84.00	139.80
B00111	02/02/91 Blue Diamond Baseball	6	126.00	209.70
B00113	02/06/91 Westfield Recreation	6	126.00	209.70
B00114	02/08/91 Hartford Recreation Office	7	147.00	244.65
B00116	02/15/91 Southside Raiders	3	63.00	104.85
B00117	02/19/91 Dayton Little Devils Baseball	1	21.00	34.95
B00118	02/21/91 Hackensack Hackers	9	189.00	314.55
B00119	02/23/91 Lakewood Little League	10	210.00	349.50
B00120	02/25/91 Princeton Amateur League	2	42.00	69.90
B00121	02/27/91 Hackensack Hackers	3	63.00	104.85
B00124	03/02/91 Blue Diamond Baseball	6	126.00	209.70
B00125	03/04/91 Paramus Little League	7	147.00	244.65
B00126	03/05/91 Hartford Recreation Office	2	42.00	69.90
B00128	03/08/91 Dayton Little Devils Baseball	3	63.00	104.85
B00128	03/08/91 Dayton Little Devils Baseball	9	189.00	314.55
B00129	03/10/91 Southside Raiders	9	189.00	314.55
B00130	03/14/91 Warren Baseball Club	9	189.00	314.55
B00132	03/15/91 Warren Baseball Club	2	42.00	69.90
B00133	03/16/91 Team Sports	2	42.00	69.90
B00134	03/18/91 Westfield Recreation	7	147.00	244.65
B00136	03/24/91 Lakewood Little League	7	147.00	244.65
B00140	04/05/91 Paramus Little League	2	42.00	69.90
B00141	04/06/91 Fords Little League All Stars	7	147.00	244.65
B00144	04/13/91 Team Sports	10	210.00	349.50
B00147	04/18/91 Lakewood Little League	3	63.00	104.85
B00148	04/19/91 Southside Raiders	2	42.00	69.90
		159	3339.00	5557.05

UT-XRCD04
01/27/95

Thoroughbred Software International, Inc.
REPORT-IV Example - Sales by Item

Page: 7
12:46 PM

MITTL Left Handed Fielders Mitt PAYPHONE.WMF

		MTD	YTD
Units:		13	95
Sales Price:	34.95	454.35	3320.25
Actual Cost:	22.00	286.00	2090.00
Margin:	37.05%	168.35	1230.25

Invoice Date	Customer	Quantity	Cost	Price
B00102	01/06/91 Westfield Recreation	10	220.00	349.50
B00103	01/12/91 Princeton Amateur League	5	110.00	174.75
B00103	01/12/91 Princeton Amateur League	9	198.00	314.55
B00105	01/18/91 Hackensack Hackers	3	66.00	104.85
B00107	01/21/91 Hartford Recreation Office	2	44.00	69.90
B00109	01/29/91 Fords Little League All Stars	2	44.00	69.90
B00110	02/01/91 Princeton Amateur League	7	154.00	244.65
B00118	02/21/91 Hackensack Hackers	3	66.00	104.85
B00121	02/27/91 Hackensack Hackers	2	44.00	69.90
B00121	02/27/91 Hackensack Hackers	1	22.00	34.95
B00122	02/27/91 Team Sports	1	22.00	34.95
B00124	03/02/91 Blue Diamond Baseball	2	44.00	69.90
B00125	03/04/91 Paramus Little League	2	44.00	69.90
B00126	03/05/91 Hartford Recreation Office	7	154.00	244.65
B00126	03/05/91 Hartford Recreation Office	7	154.00	244.65
B00131	03/14/91 Team Sports	3	66.00	104.85
B00136	03/24/91 Lakewood Little League	2	44.00	69.90
B00137	03/24/91 Hackensack Hackers	5	110.00	174.75
B00138	03/29/91 Blue Diamond Baseball	4	88.00	139.80
B00139	03/30/91 Hartford Recreation Office	5	110.00	174.75
B00140	04/05/91 Paramus Little League	2	44.00	69.90
B00143	04/11/91 Blue Diamond Baseball	2	44.00	69.90
B00144	04/13/91 Team Sports	9	198.00	314.55
		95	2090.00	3320.25

UT-XRCD04
01/27/95

Thoroughbred Software International, Inc.
REPORT-IV Example - Sales by Item

Page: 8
12:46 PM

BASEBALLS Little League Baseballs (DozAPPTBOOK.WMF)

	MTD	YTD
Units:	10	41
Sales Price: 29.95	299.50	1227.95
Actual Cost: 18.95	189.50	776.95
Margin: 36.73%	110.00	451.00

Invoice Date	Customer	Quantity	Cost	Price
B00104	01/15/91 Lakewood Little League	2	37.90	59.90
B00108	01/24/91 Paramus Little League	1	18.95	29.95
B00109	01/29/91 Fords Little League All Stars	2	37.90	59.90
B00111	02/02/91 Blue Diamond Baseball	2	37.90	59.90
B00112	02/05/91 Team Sports	2	37.90	59.90
B00113	02/06/91 Westfield Recreation	2	37.90	59.90
B00115	02/14/91 Lakewood Little League	2	37.90	59.90
B00119	02/23/91 Lakewood Little League	2	37.90	59.90
B00122	02/27/91 Team Sports	1	18.95	29.95
B00125	03/04/91 Paramus Little League	2	37.90	59.90
B00126	03/05/91 Hartford Recreation Office	2	37.90	59.90
B00127	03/05/91 Westfield Recreation	2	37.90	59.90
B00127	03/05/91 Westfield Recreation	2	37.90	59.90
B00127	03/05/91 Westfield Recreation	1	18.95	29.95
B00128	03/08/91 Dayton Little Devils Baseball	2	37.90	59.90
B00132	03/15/91 Warren Baseball Club	2	37.90	59.90
B00138	03/29/91 Blue Diamond Baseball	2	37.90	59.90
B00141	04/06/91 Fords Little League All Stars	2	37.90	59.90
B00143	04/11/91 Blue Diamond Baseball	2	37.90	59.90
B00145	04/15/91 Westfield Recreation	2	37.90	59.90
B00146	04/18/91 Hartford Recreation Office	2	37.90	59.90
B00146	04/18/91 Hartford Recreation Office	2	37.90	59.90
		41	776.95	1227.95

UT-XRCD04
01/27/95

Thoroughbred Software International, Inc.
REPORT-IV Example - Sales by Item

Page: 9
12:46 PM

BASES		Set of 4 Bases	CHECK.WMF	MTD	YTD
			Units:	2	8
			Sales Price:	86.00	344.00
			Actual Cost:	58.00	232.00
			Margin:	28.00	112.00
Invoice Date	Customer		Quantity	Cost	Price
B00107	01/21/91 Hartford Recreation Office		1	29.00	43.00
B00114	02/08/91 Hartford Recreation Office		1	29.00	43.00
B00118	02/21/91 Hackensack Hackers		1	29.00	43.00
B00125	03/04/91 Paramus Little League		1	29.00	43.00
B00128	03/08/91 Dayton Little Devils Baseball		1	29.00	43.00
B00132	03/15/91 Warren Baseball Club		1	29.00	43.00
B00141	04/06/91 Fords Little League All Stars		1	29.00	43.00
B00147	04/18/91 Lakewood Little League		1	29.00	43.00
			8	232.00	344.00

UT-XRCD04
01/27/95

Thoroughbred Software International, Inc.
REPORT-IV Example - Sales by Item

Page: 10
12:46 PM

CATCHER		Catchers Equipment	SATEDISH.WMF	
			MTD	YTD
			-----	-----
			Units:	2
			Sales Price:	211.90
			Actual Cost:	149.90
			Margin:	62.00
				21
				2224.95
				1573.95
				651.00
Invoice Date	Customer	Quantity	Cost	Price

B00100	01/05/91 Warren Baseball Club	1	74.95	105.95
B00101	01/05/91 Team Sports	1	74.95	105.95
B00103	01/12/91 Princeton Amateur League	1	74.95	105.95
B00111	02/02/91 Blue Diamond Baseball	1	74.95	105.95
B00112	02/05/91 Team Sports	1	74.95	105.95
B00115	02/14/91 Lakewood Little League	1	74.95	105.95
B00116	02/15/91 Southside Raiders	1	74.95	105.95
B00119	02/23/91 Lakewood Little League	1	74.95	105.95
B00120	02/25/91 Princeton Amateur League	1	74.95	105.95
B00121	02/27/91 Hackensack Hackers	1	74.95	105.95
B00122	02/27/91 Team Sports	1	74.95	105.95
B00127	03/05/91 Westfield Recreation	1	74.95	105.95
B00127	03/05/91 Westfield Recreation	1	74.95	105.95
B00129	03/10/91 Southside Raiders	1	74.95	105.95
B00129	03/10/91 Southside Raiders	1	74.95	105.95
B00133	03/16/91 Team Sports	1	74.95	105.95
B00133	03/16/91 Team Sports	1	74.95	105.95
B00135	03/21/91 Princeton Amateur League	1	74.95	105.95
B00137	03/24/91 Hackensack Hackers	1	74.95	105.95
B00145	04/15/91 Westfield Recreation	1	74.95	105.95
B00146	04/18/91 Hartford Recreation Office	1	74.95	105.95
			-----	-----
			21	1573.95
				2224.95

EXTERNAL INTERFACES

Report-IV allows you to integrate single or multiple reports into existing application programs, such as a Thoroughbred Script-IV program or a Thoroughbred Basic program.

Script-IV

To generate report(s) from a script, refer to the script **IDAUTO** to view or edit the sample Report-IV external interface. The routine specified in this section illustrates how to build the values required to run a single report or multiple reports. The **UTXCUSLS** sample script, which generates reports, is provided.

Thoroughbred Basic

To generate report(s) from a Thoroughbred Basic program, incorporate the routine specified in this section into your existing program. This routine builds the values required to run a single report or multiple reports.

NOTE: Within this Thoroughbred Basic code, the comment lines [!] are for explanation only.

```
0200      REM "*Build X$ For Thoroughbred REPORT-IV*"
0210      DIM X$(84)
                                ! Required as shown
0220      LET X$(1,4) = "AUTO"
                                ! Required as shown
0230      LET X$(5,8) = LIB-NAME + FROM-NAME
                                ! The first 2 characters are the
                                ! library name. Characters 3 - 8
                                ! are the starting report name.
                                ! Example: "UTXRCD01"
0240      LET X$(72,6) = TO-NAME
                                ! Characters 1-6 are the ending
                                ! report name.
                                ! Example: "XRCD03"
                                ! The report definitions in the
                                ! specified range must reside
                                ! in the same library.
0250      LET X$(78,6) = MASK-NAME
                                ! Characters 1-6 are the mask
                                ! for the report name . Use valid
                                ! . mask characters or use a null
                                ! .string " " for no mask.
```

```
0260    LET X$(40,8) = PROGRAM-NAME
        ! Set PROGRAM-NAME to any
        !.valid program name to exit to
        !.after executing the report(s).
        !.Example: "ID"

0270    LET X$(68,2) = HARD-COPY
        ! Options are:
        ! " " - (null string) prompt user for
        !       standard print option
        !       prompts.
        ! "Y"- print hard copy.
        ! "N"- display on terminal screen.
        ! PN - Assign a 2-character printer
        !       name/ID and bypass standard
        !       print option prompts.
        !.Example: "LP"

0280    LET X$ (49,2) = "  "
        ! These 2 bytes allow you to
        !.specify an Dictionary-IV predefined
        !.sort number for the report. You
        !.must have a SORT BY SORT Ø
        !.clause in the report to use this
        !. feature.

0290 CALL "IRPCA0"
        ! Required as shown
```

TRANSFERRING QUERIES TO REPORT-IV

Creating queries using Thoroughbred Query-IV allows you to easily perform inquiries on part or all of your database. Thoroughbred extends the capabilities of Query-IV by providing a way to convert an existing query into a report definition that can be used in Thoroughbred Report-IV.

Requirements

The following requirements must be met to convert a query into a report definition:

- The query must already exist. You must have entered a query name and saved it using Query Maintenance.
- There cannot be an existing report with the same name as the query name.

Procedure

Run Thoroughbred Report-IV by beginning at the Dictionary-IV Development Menu. Select **1. Edit Definition** or press the **F1** key from any Dictionary-IV menu. The system displays the following pop-up menu:

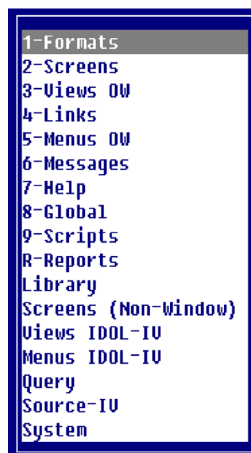

At the pop-up menu select **R-Reports**.

Enter the Query Name into the REPORT name field. The query is automatically converted into a report at this point, provided a report with this name does not already exist. The query description is displayed as the description for the report, and the report width is automatically calculated from the query.

Display the report definition. Use the cursor control keys to bypass the fields in the report definition header by pressing the **Enter** key until the report definition is displayed. Standard maintenance can now be performed on the report definition.

NOTE: As soon as you enter the query name in Thoroughbred Report-IV, the report definition is created. If you change the query and later want to convert it into a report definition again, you must first delete the old report definition.